

Automatic lubricators

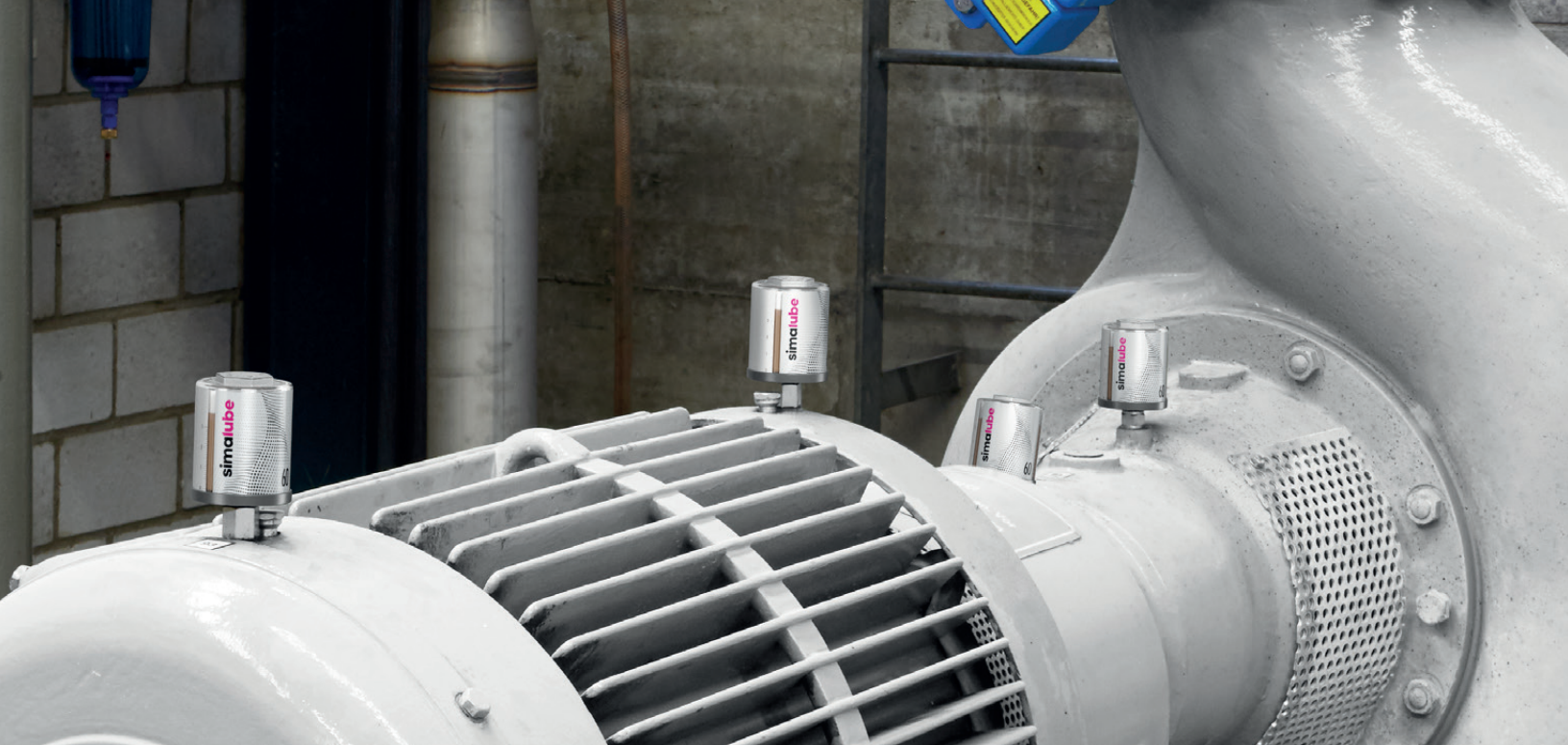

simalube

 SWISS MADE



simalube

Advantages of automatic lubrication with simalube	3
simatec app «simatec world of maintenance»	4
simalube – the lubrication expert	5/6
simalube 15 ml	7
simalube IMPULSE connect	8
simalube multipoint	9
Applications	10/11
Standard lubricants	12/13
Accessories	13/14/15

simalube: continuous lubrication ensures low costs and high reliability

Millions of simalube lubricators are used worldwide in every industry. They are the best and most economical solution for the continuous supply of grease or oil for periods of up to one year.

simalube – everywhere forces act, something spins or something moves.

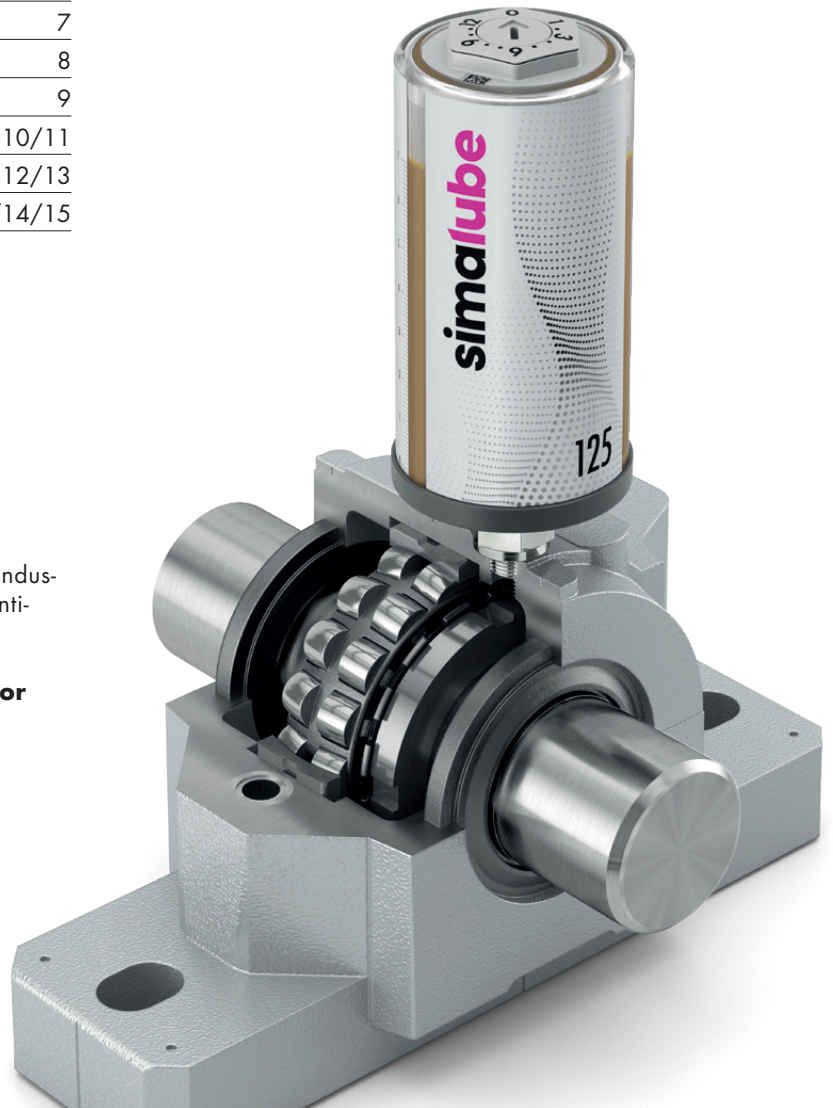

Advantages of automatic lubrication with simalube

simalube lubricators replace costly manual lubrication. This not only saves time, but also prevents insufficient or over-lubrication. The costs can thus be reduced by up to 30 percent.

Optimized lubricant delivery

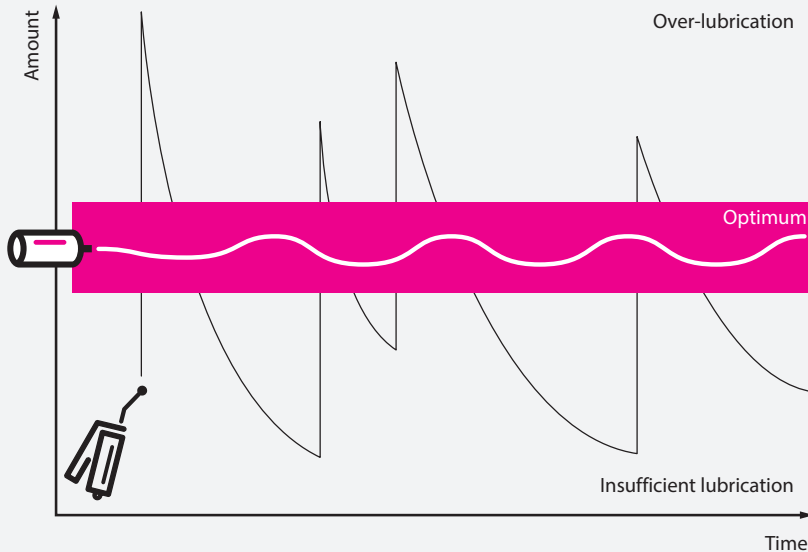

Continuous lubricant delivery with simalube effectively prevents insufficient or over-lubrication that often occurs with manual lubrication.

Lower costs thanks to simalube

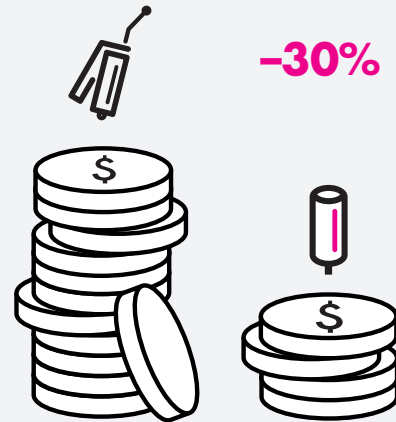

Up to 30 percent lower costs:

- Time-saving and greater safety at work thanks to fewer maintenance intervals
- Longer machine service life and less unplanned down-time

Your benefits of automatic lubrication with simalube



No more manual lubrication

- Saves time
- Greater work safety
- Hard-to-reach lubrication points are permanently supplied
- Lower lubricant consumption



No under- or over-lubrication of components

- Less wear
- Less machine downtime
- Increased machine performance

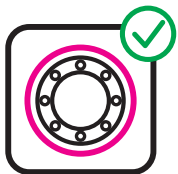

Sealed, dustproof and waterproof system

- No more confusion of lubricants
- Reduced risk of contamination
- No contamination of lubrication points



Compliance with international standards

- Ex certified in all zones
- Improved workplace safety
- No environmental impact thanks to recycling and disposal according to regulations



READY TO LIFT OFF TO THE WORLD OF MAINTENANCE

Explore the next level of automatic lubrication: **simalube IMPULSE connect**



simatec app «simatec world of maintenance»

With the simatec app «simatec world of maintenance», simatec ag has created a platform for simpler and more efficient management of lubrication work. The app offers the user the options of recording lubrication points, recording the required parameters for lubrication and controlling or monitoring all activities related to lubrication.

Your personal simatec assistant for efficient and connected monitoring

Functionality

- Configuration and monitoring of lubrication points with the «simatec world of maintenance» app
- Creation of electronic lubrication schedules (Lubechart)
- Calculation program for the correct setting of your lubricators (Calculation Pro)

Customer benefits

- simatec products can be controlled with the «simatec world of maintenance» app
- Creation of personalized, electronic lubrication plans with continuous monitoring of all lubrication points
- Thanks to the new Lubechart feature, all lubrication points (manual/automatic) can be managed
- Cost savings thanks to safe, simplified and efficient maintenance operations
- Installation videos help with the correct installation of the products
- No production interruptions for maintenance and monitoring purposes, resulting in higher availability of the production facilities



Get the app «simatec world of maintenance»



The lubrication expert



simalube – the automatic single-point lubricator

Available in 5 sizes, simalube supplies various lubrication points with lubricant around the clock. Day in, day out – for up to one year.

Take advantage of the simalube benefits

Reliability

- Lubrication points are continuously supplied with lubricant
- No lubrication point is missed
- Easy monitoring of the dispensing process thanks to the transparent housing

Environmental sustainability

- simalube can be refilled up to 3 times
- Easy disposal at the end of the dispensing cycle
- simalube lubricators do not contain toxic substances

Flexibility

- simalube is available in 5 sizes: 15, 30, 60, 125 and 250 ml
- Freely selectable dispensing cycle of 1 to 12 months
- Dispensing cycle can be modified anytime
- simalube is available filled or empty for self-filling

Unlimited range of uses (see pages 10/11)

- In confined and hard-to-reach spaces
- In any location, even underwater
- At ambient temperatures of -20°C to $+55^{\circ}\text{C}$
- Numerous installation options thanks to a large range of accessories
- The standard lubricant range includes modern and proven high-performance lubricants for all applications (see pages 12/13)

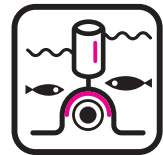
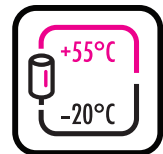
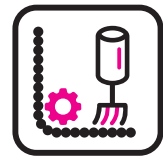

For more technical information, see
www.simatec-usa.com/en/simalube/overview/technical-data



Components

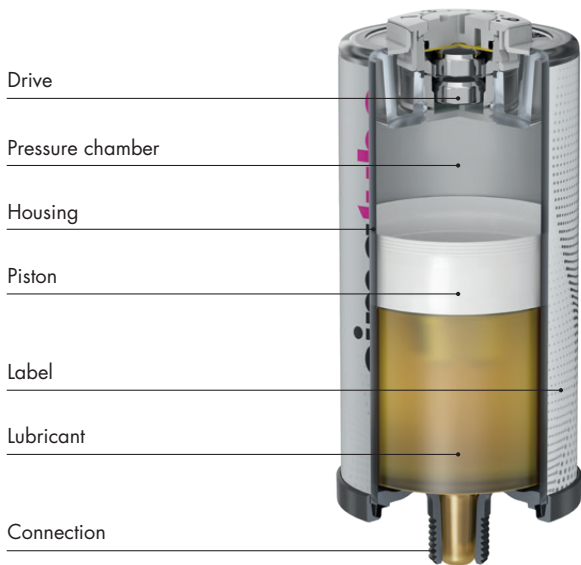

Specifications

Product	Automatic long-term grease and oil lubricator			
Power generation	Hydrogen gas producing drycell			
Working pressure	Max. 72.5 psi			
Adjustment	Stepless 1–12 months (for standard conditions)			
Operating temperature	–4 °F to +131 °F ambient temperature (Grease consistency changes with temperature)			
Storage temperature	Recommended at 68 °F ±41 °F			
Lubricator volume	30 ml	60 ml	125 ml	250 ml
Weight full	~83 g	~117 g	~191 g	~380 g
Weight empty	~56 g	~65 g	~80 g	~154 g
Refill	The 15–250 ml simalubes are refillable.			



Certifications

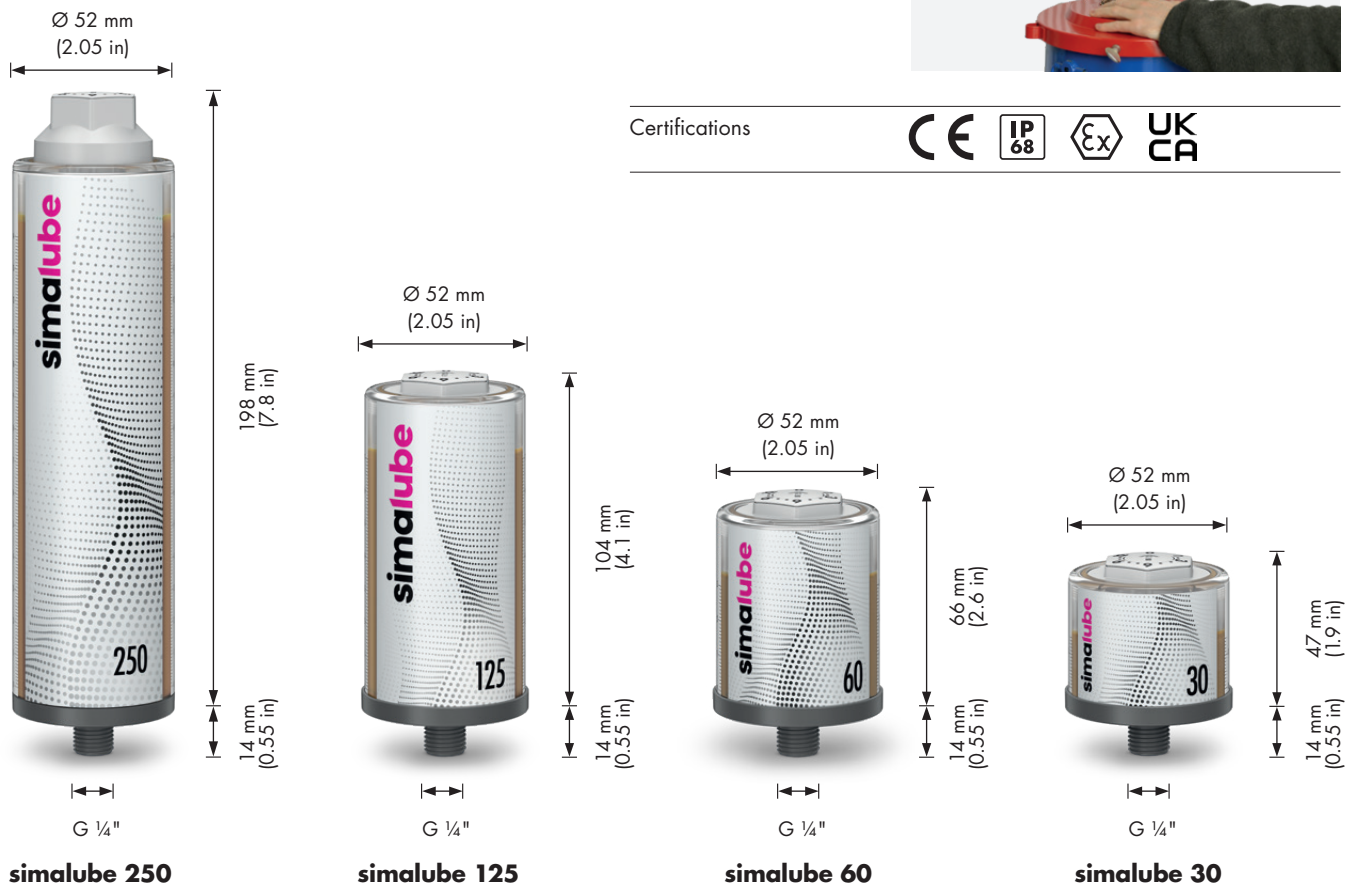

simalube 15 ml



The smallest automatic lubricator

In confined spaces, the 15 ml simalube offers the perfect solution. With its compact size, it is unique on the global market as the smallest automatic lubricator. It functions the same as the larger simalube lubricators and offers the same advantages.



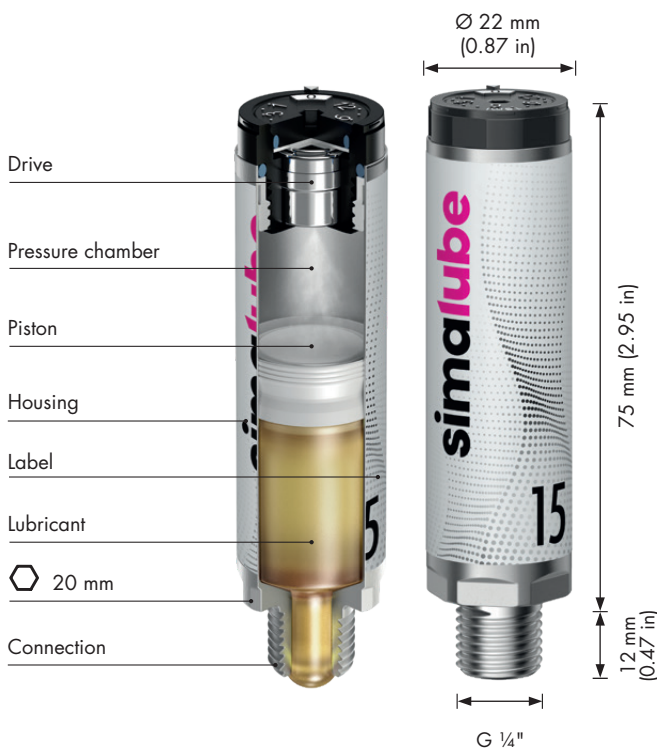

Small size delivers big performance

- Space-saving thanks to compact size
- Robust aluminium enclosure
- Same refill, installation and function as other simalube lubricators
- Alternative to the simalube multipoint when less than 5 lubrication points are needed (see page 9)

Dimensions



Specifications

Product	Automatic, long-term grease and oil lubricator
Power generation	Hydrogen gas producing drycell
Working pressure	Max. 72.5 psi
Adjustment	Stepless 1–12 months (for standard conditions)
Operating temperature	–4 °F to +131 °F ambient temperature (Grease consistency changes with temperature)
Storage temperature	Recommended at 68 °F ±41 °F
Lubricator volume	15 ml
Weight full/empty	~36 g / ~22,5 g
Certifications	   

simalube IMPULSE connect



Digital pressure booster up to 145 psi

The simalube IMPULSE connect is the latest generation of the pressure booster from the simalube family. The proven functions of the IMPULSE have been supplemented with the option of connecting the device to a smartphone via Bluetooth®. In connection with the newly developed «simatec world of maintenance» app, the devices can be easily configured and then monitored without having to be directly at the lubrication point. Information such as general status, fill level, lubricant, size, start and change date etc. is displayed to the user and easy to read in the app.

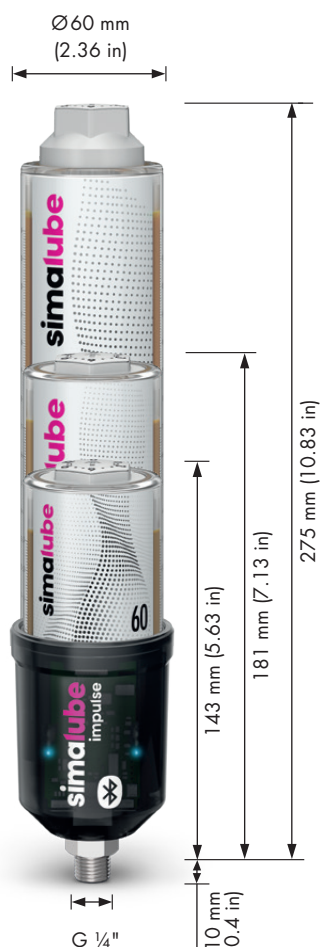

Technical data

Product	Automatic pressure booster for the simalube lubricator
Drive system	Electromechanical
Power supply	Battery pack* 6 V 2.3 Ah (Alkaline)
Function display	LED status display – green/red/blue every 10 seconds. Monitoring of the operating status via the «simatec world of maintenance» app.
Connectivity**	IMPULSE connect supports Bluetooth® Low Energy 5.0 standard. The connection can reach up to 20 m in an interference free open field environment.
Dispensing volume	0.5 ml per stroke (Impulse)
Working pressure	Up to 145 psi
Operating temperature	14 °F to 131 °F
Time setting	1 to 12 months – determined by the setting on the simalube «Automatic» mode or the «Time» mode preselected with the app.
Lubrication rate	Depends on the size and settings of the simalube: 0.17 to 8.3 ml/day
Lubricator volume	60 ml, 125 ml, 250 ml
Lubricant	Lubricant greases up to NLGI 2 or oils
Connection thread	G ¼" (with integrated non-return valve)
Warranty & period of use	3 years from the production date or until 10 simalube lubricators (125 ml) have been emptied
Protection rating	CE IP 68

* The battery pack must be replaced every time the lubricator is replaced.

** The IMPULSE connect can be used without the app.

<https://simatec-usa.com/en/simalube/simalube-impulse-connect>



More technical information and a video for simalube IMPULSE connect can be found at www.simatec-usa.com/en/simalube/simalube-impulse-connect



simalube multipoint

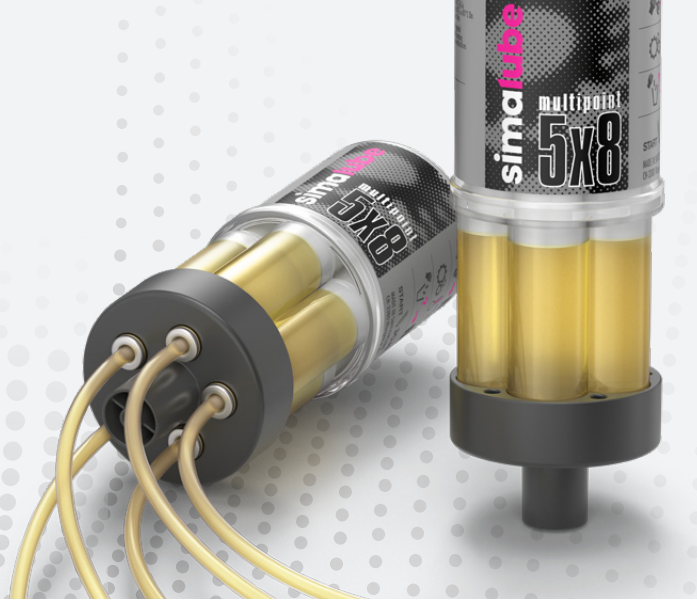

Automatic multi-point lubricator

The simalube multipoint supplies 5 lubrication points simultaneously for up to one year in the same reliable way as the other proven simalube lubricators. Thanks to the snap-on connector, simalube multipoint can be replaced easily and quickly when empty.



The versatile lubricator for linear guides

- 5x8 ml lubricant volume
- Allows very low lubricant delivery over a long period of time
- Snap-on connector for multipoint
- Quick couplings for connecting hoses
- Ideally suited for lubrication of linear guides

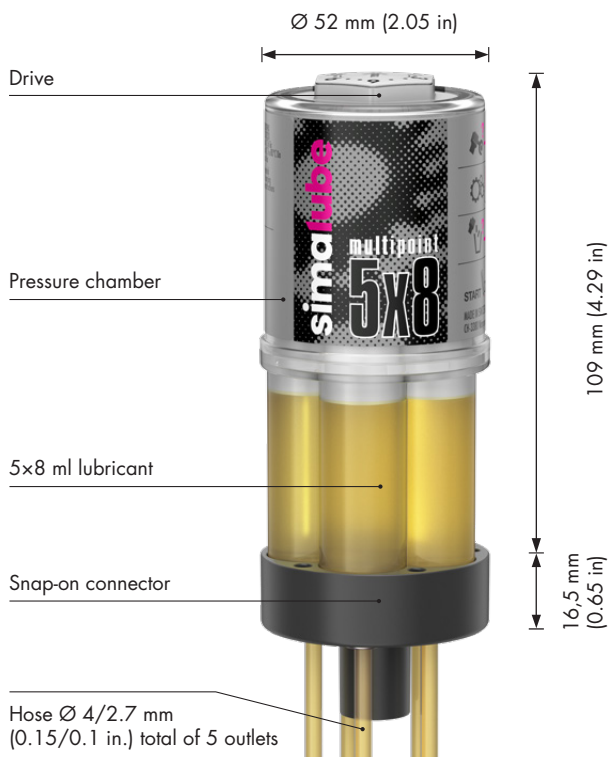
Dimensions



Specifications

Product	Automatic, multi-point, long-term lubricators for grease and oil
Power generation	Hydrogen gas producing drycell
Working pressure	Max. 72.5 psi
Adjustment	Stepless 1–12 months (for standard conditions)
Operating temperature	14 °F to +131 °F ambient temperature (grease consistency changes with temperature)
Storage temperature	Recommended at 68 °F ±41 °F
Lubricator volume	5x8 ml
Weight full/empty	~147 g / ~120 g
Certifications	  

simalube applications



Lifting devices



The spindles of a lifting station for railway wagons and locomotives are lubricated with 125 ml simalube over 12 months.

Food industry

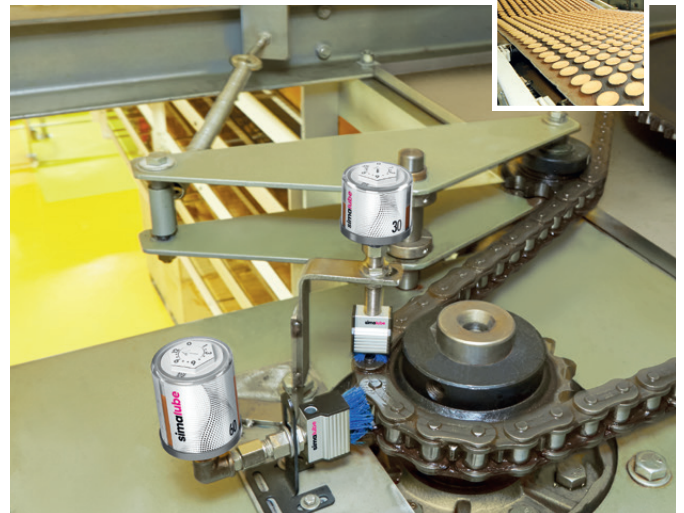

The drive chain of a transport belt, which allows rolls to cool, is cleaned with special blue brushes and lubricated with 2 simalube SL18 in 30 and 60 ml sizes.

Gravel and concrete plants



Two 250 ml simalube lubricators with brushes lubricate and clean the chain drive of a drum washing machine.

Cranes

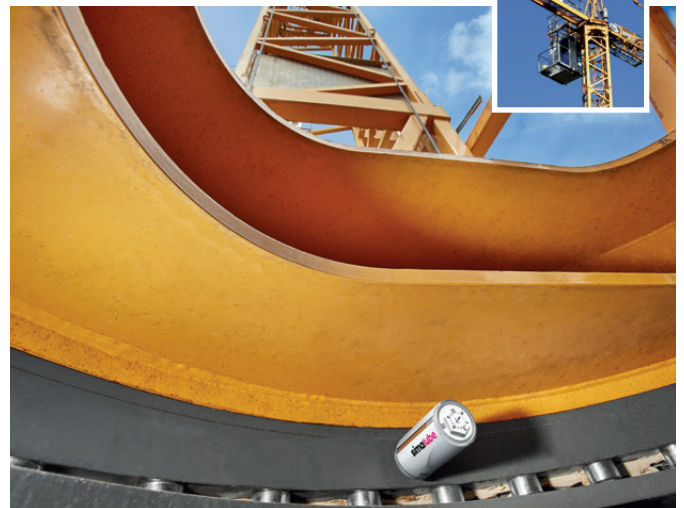

125 ml simalube lubricators lubricate the rotating assembly of a crane.

Gravel and concrete plants



The simalube IMPULSE connect with a 125 ml lubricator is used in gravel plants. The devices are configured and monitored via the «simatec world of maintenance» app.

Elevators and escalators



The 125 ml simalube maintains the guide rails of elevators and prevents dry friction. The system is attached directly to the cabin roof.

Printing industry



A simalube multipoint can lubricate 5 linear guides of a cutting and paper stacking machine in a printing house.

Water and sewage treatment plants

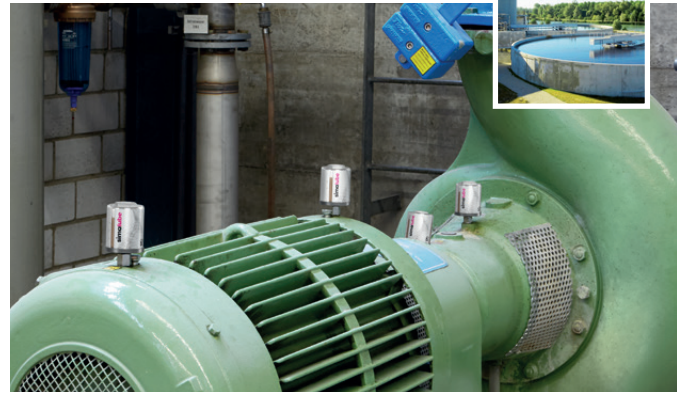

60 ml lubricators on the electric motor and the drive shaft ensure continuous lubrication of a centrifugal pump.

Recycling



A 125 ml simalube lubricates the pedestal bearing of a conveyor belt.

Machinery and plant engineering

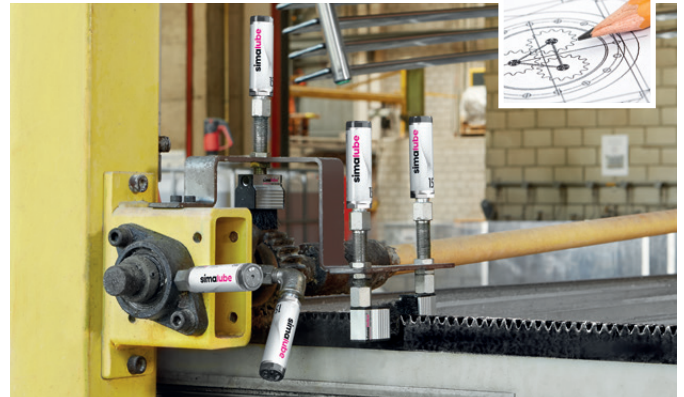

15 ml simalube lubricators with brushes constantly supply the rack of a loading machine with oil. Additional 15 ml simalube lubricators lubricate the flange bearings with grease.



Many other applications can be found at
www.simatec-usa.com/en/simalube/industries



simalube standard lubricants and accessories



GREASE	NLGI	Thickener	Temperature range	Viscosity at 104 °F	Roller bearings	Plain bearings	Linear guides	Gears/Toothed racks	Spindles	Shaft seals	Chains
SL01 General multi-purpose industrial grease	2	Lithium	-4 °F to +266 °F	160	+	+	•	•	+	+	-
SL02 High-performance grease with MoS ₂	2	Lithium-Complex	-4 °F to +293 °F	320	•	+	-	+	-	-	-
SL04 High temperature grease	1	Clay	+32 °F to +338 °F	495	+	•	-	•	•	-	-
SL06 Fluid grease	0	Lithium	-4 °F to +266 °F	160	+	+	+	+	•	-	-
SL09 Biodegradable grease	2	Lithium	-40 °F to +248 °F	100	+	+	•	•	-	-	-
SL10 High performance multi-purpose grease for the food industry	2	Aluminium complex	-4 °F to +248 °F	220	+	+	•	+	•	-	-
SL22 Electric motor bearing grease	2	Polyurea	-4 °F to +320 °F	115	+	•	-	-	+	-	-
SL23 Synthetic high temperature food grade grease	2	Polyurea	-4 °F to +338 °F	460	+	+	-	-	-	-	-
SL25 High pressure grease	2	Polyurea	-4 °F to +320 °F	235	+	+	•	•	•	-	-

+ recommended • possible - not recommended



Datasheets are available for all greases and oils at www.simatec-usa.com/en/simalube/overview/lubricants



OIL	ISO-VG	Base oil	Temperature range	Viscosity at 104 °F	Roller bearings	Plain bearings	Linear guides	Gears/Toothed racks	Spindles	Shaft seals	Chains
SL14 Chain oil	68	Mineral oil	N/A	68	-	•	•	-	-	-	+
SL15 High temperature chain oil	220	Synthetic oil	-22 °F to +527 °F	220	-	•	•	-	-	-	+
SL18 Food grade oil	68	Synthetic oil	N/A	68	-	•	•	-	-	-	+

+ recommended • possible - not recommended

Application examples

The simalube can be easily installed anywhere and in any position with these accessories.

Chain lubrication with lateral connection

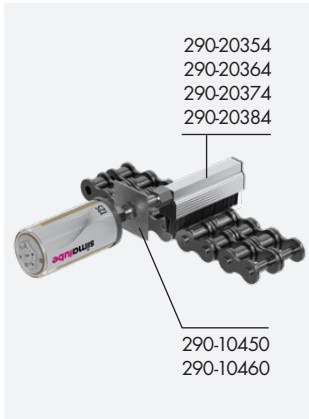

Mounting bracket

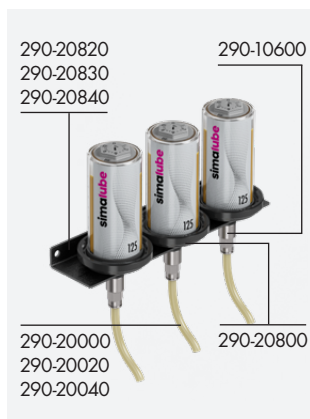

Lubrication of elevator guides or wire ropes



Chain lubrication with round brush and two clamps

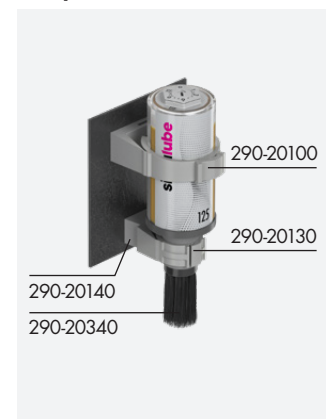

Mounting support with protective cover for simalube

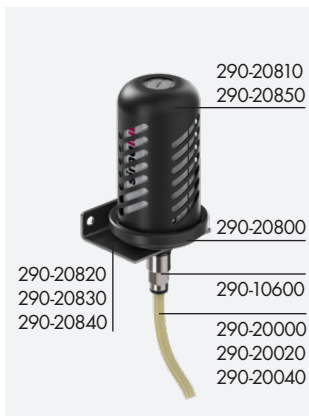

Chain lubrication with clamp

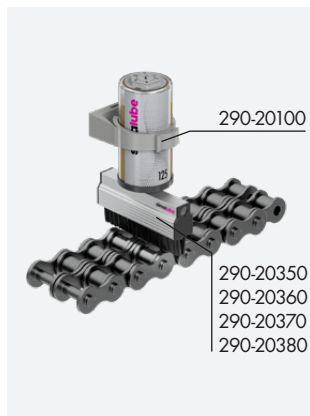

Round brush with 90° connection

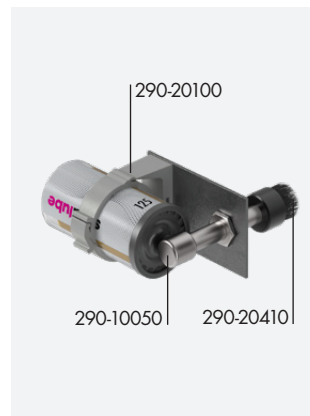

Chain lubrication with bracket, universally adjustable

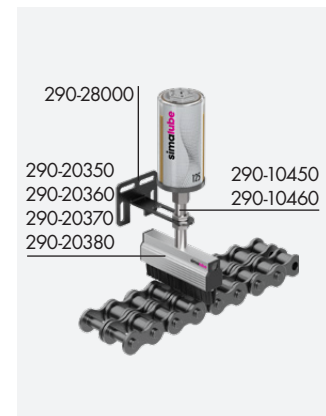

Connections

	<p>Bent connection 45°</p> <p>D R 1/4 Nr. 290-10010</p>		<p>Reducing nipple</p> <table border="1"> <tr> <td>D</td> <td>G 1/8</td> <td>G 1/4</td> <td>M 6</td> <td>M 8</td> <td>M 8x1</td> </tr> <tr> <td>Nr.</td> <td>290-10200</td> <td>290-10210</td> <td>290-10220</td> <td>290-10230</td> <td>290-10240</td> </tr> </table> <table border="1"> <tr> <td>D</td> <td>M 10</td> <td>M 10x1</td> <td>M 12</td> <td>M 12x1,5</td> <td>UNF 1/4</td> </tr> <tr> <td>Nr.</td> <td>290-10250</td> <td>290-10260</td> <td>290-10270</td> <td>290-10280</td> <td>290-11210</td> </tr> </table>	D	G 1/8	G 1/4	M 6	M 8	M 8x1	Nr.	290-10200	290-10210	290-10220	290-10230	290-10240	D	M 10	M 10x1	M 12	M 12x1,5	UNF 1/4	Nr.	290-10250	290-10260	290-10270	290-10280	290-11210
D	G 1/8	G 1/4	M 6	M 8	M 8x1																						
Nr.	290-10200	290-10210	290-10220	290-10230	290-10240																						
D	M 10	M 10x1	M 12	M 12x1,5	UNF 1/4																						
Nr.	290-10250	290-10260	290-10270	290-10280	290-11210																						
	<p>Bent connection 90°</p> <p>D R 1/4 Nr. 290-10020</p>		<p>Reducing nipple strong version Inox</p> <table border="1"> <tr> <td>D</td> <td>M6</td> <td>UNF 1/4</td> </tr> <tr> <td>Nr.</td> <td>290-15000</td> <td>290-15010</td> </tr> </table>	D	M6	UNF 1/4	Nr.	290-15000	290-15010																		
D	M6	UNF 1/4																									
Nr.	290-15000	290-15010																									
	<p>Bent connection 90° swiveling</p> <p>D R 1/4 Nr. 290-10040</p>		<p>Extension</p> <table border="1"> <tr> <td>L</td> <td>10</td> <td>35</td> <td>50</td> <td>[mm]</td> </tr> <tr> <td>Nr.</td> <td>290-10210</td> <td>290-10400</td> <td>290-10410</td> <td></td> </tr> </table>	L	10	35	50	[mm]	Nr.	290-10210	290-10400	290-10410															
L	10	35	50	[mm]																							
Nr.	290-10210	290-10400	290-10410																								
	<p>Rotary elbow for hose Ø 8 mm</p> <p>D G 1/4 Nr. 290-10030</p>		<p>Screwed connection with hole 25 mm incl. 1 nut / 60 mm, incl. 2 nuts</p> <table border="1"> <tr> <td>L</td> <td>25</td> <td>60</td> <td>[mm]</td> </tr> <tr> <td>Nr.</td> <td>290-10450</td> <td>290-10460</td> <td></td> </tr> </table>	L	25	60	[mm]	Nr.	290-10450	290-10460																	
L	25	60	[mm]																								
Nr.	290-10450	290-10460																									
	<p>Rotary elbow for hose Ø 8 mm</p> <p>D G 1/8 G 1/4 Nr. 290-10070 290-10080</p>		<p>Quick connection for hose Ø 8 mm</p> <p>D G 1/4 Nr. 290-10600</p>																								
	<p>Connection 90° with thread incl. 2 nuts (only for oil)</p> <p>L 70 [mm] Nr. 290-10050</p>		<p>Quick connection for hose Ø 8 mm</p> <table border="1"> <tr> <td>D</td> <td>G 1/8</td> <td>G 1/4</td> <td>G 3/8</td> </tr> <tr> <td>Nr.</td> <td>290-10700</td> <td>290-10710</td> <td>290-10720</td> </tr> </table>	D	G 1/8	G 1/4	G 3/8	Nr.	290-10700	290-10710	290-10720																
D	G 1/8	G 1/4	G 3/8																								
Nr.	290-10700	290-10710	290-10720																								
	<p>Connecting nipple</p> <table border="1"> <tr> <td>D</td> <td>G 3/8</td> <td>G 1/2</td> </tr> <tr> <td>Nr.</td> <td>290-10100</td> <td>290-10110</td> </tr> </table>	D	G 3/8	G 1/2	Nr.	290-10100	290-10110		<p>4-fold adapter</p> <table border="1"> <tr> <td>D</td> <td>G 1/2</td> <td>G 1/4</td> </tr> <tr> <td>Nr.</td> <td>290-41000</td> <td>290-41010</td> </tr> </table>	D	G 1/2	G 1/4	Nr.	290-41000	290-41010												
D	G 3/8	G 1/2																									
Nr.	290-10100	290-10110																									
D	G 1/2	G 1/4																									
Nr.	290-41000	290-41010																									
	<p>Fixation nipple G 1/2" - R 1/4"</p> <p>L 25 [mm] Nr. 290-10150</p>		<p>2-fold adapter</p> <table border="1"> <tr> <td>D</td> <td>G 1/2</td> <td>G 1/4</td> </tr> <tr> <td>Nr.</td> <td>290-41020</td> <td>290-41030</td> </tr> </table>	D	G 1/2	G 1/4	Nr.	290-41020	290-41030																		
D	G 1/2	G 1/4																									
Nr.	290-41020	290-41030																									

Lubricator accessories and miscellaneous

	<p>Filling nipple for cleaning and filling of grease lines</p> <p>D R 1/4 Nr. 290-30110</p>		<p>Gas generator for refilling</p> <table border="1"> <tr> <td></td> <td>15 ml</td> <td>30 ml</td> <td>60 ml</td> <td>125 ml</td> <td>250 ml</td> </tr> <tr> <td>Nr.</td> <td>220-50020</td> <td>220-50040</td> <td>220-50060</td> <td>220-50080</td> <td>220-50100</td> </tr> </table>		15 ml	30 ml	60 ml	125 ml	250 ml	Nr.	220-50020	220-50040	220-50060	220-50080	220-50100						
	15 ml	30 ml	60 ml	125 ml	250 ml																
Nr.	220-50020	220-50040	220-50060	220-50080	220-50100																
	<p>Refill nipple for refilling of simalube</p> <p>D G 1/4 Nr. 290-30120</p>		<p>Non-return valve plug Plastic</p> <p>Nr. 290-50600</p>																		
	<p>Refill nipple for filling the simalube with grease gun filler</p> <table border="1"> <tr> <td>D</td> <td>R 1/4</td> <td>R 3/8</td> </tr> <tr> <td>Nr.</td> <td>290-30130</td> <td>290-30140</td> </tr> </table>	D	R 1/4	R 3/8	Nr.	290-30130	290-30140		<p>Non-return valve</p> <table border="1"> <tr> <td>D</td> <td>G 1/8</td> <td>G 1/4</td> <td>G 1/4</td> </tr> <tr> <td>Nr.</td> <td>290-20200</td> <td>290-20210</td> <td>290-20230</td> </tr> <tr> <td>Bar</td> <td>0.05</td> <td>0.05</td> <td>1.0</td> </tr> </table>	D	G 1/8	G 1/4	G 1/4	Nr.	290-20200	290-20210	290-20230	Bar	0.05	0.05	1.0
D	R 1/4	R 3/8																			
Nr.	290-30130	290-30140																			
D	G 1/8	G 1/4	G 1/4																		
Nr.	290-20200	290-20210	290-20230																		
Bar	0.05	0.05	1.0																		

Safety accessories

	<p>Protective cover for mounting support art. 290-20800</p> <table border="1"> <tr> <td></td> <td>30 ml</td> <td>≤125 ml</td> <td>250 ml</td> </tr> <tr> <td>L</td> <td>43</td> <td>105</td> <td>195</td> </tr> <tr> <td>Nr.</td> <td>290-20860</td> <td>290-20810</td> <td>290-20850</td> </tr> </table>		30 ml	≤125 ml	250 ml	L	43	105	195	Nr.	290-20860	290-20810	290-20850		<p>Mounting support for all simalube sizes</p> <p>D R 1/4 Nr. 290-20800</p>
	30 ml	≤125 ml	250 ml												
L	43	105	195												
Nr.	290-20860	290-20810	290-20850												

Brushes

	Round brush DxL $\varnothing 25 \times 45$ [mm] Nr. 290-20340		Brush for high temperatures H 25 [mm] Nr. 290-20500
	Round brush short DxL $\varnothing 25 \times 15$ [mm] Nr. 290-20410		Brush for high temperatures Connection on top and side H 40 100 [mm] Nr. 290-20510 290-20530
	Brush *FN for food applications L 25 40 70 100 [mm] Nr. 290-20380 290-20350 290-20360 290-20370 Nr. *290-20385 *290-20355 *290-20365 *290-20375		Elevator brush Elevator brush 5-16 mm, height 32 mm 16-32 mm, height 32 mm Nr. 290-20390 Nr. 290-20440
	Brush lateral connection *SFN for food applications L 25 40 70 100 Nr. 290-20384 290-20354 290-20364 290-20374 Nr. *290-20357 *290-20367 *290-20377		Elevator brush small 5-16 mm, height 32 mm Nr. 290-20420

Installation accessories

	a) Hose b) Hose for temperatures up to 500 °F c) Hose for small bend radius L available by the meter, $\varnothing 8/6$ mm Nr. 290-20000/...m 290-20020/...m 290-20040/...m		Distance holder to clamp for round brush art. 290-20130 H 15 [mm] Nr. 290-20140
	Clamp for simalube/round brush Plastic D 22 (SL 15 ml) 28 (Pinsel) 50 (SL 30-250 ml) [mm] Nr. 290-20150 290-20130 290-20100		Bracket to mounting support simalube art. 290-20800 L 1x 3x 5x 75 240 390 [mm] Nr. 290-20820 290-20830 290-20840
	Magnetic fixture for clamps Nr. 290-20190		Bracket for simalube 15-60 ml Nr. 290-20870
	Adapter for clamp (60 mm) Plastic D 50 [mm] Nr. 290-20120		Bracket universally adjustable Nr. 290-28000

simalube multipoint installation components

	Quick connection for hose $\varnothing 4$ mm D G 1/8 G 1/4 M 5 M 6 Nr. 290-11700 290-11710 290-11720 290-11730		Hose available by the meter L per metre $\varnothing 4/2,7$ mm Nr. 290-21000/...m
	Connection SLM D 5x4 mm Nr. 290-29000		

Grease cartridges and oil bottles for prelubrication

	Grease cartridge 400 ml SL01 SL02 SL04 SL06 SL09 Nr. 290-70010 290-70020 290-70040 290-70060 290-70090 SL10 SL12 SL24 SL22 SL26 Nr. 290-70100 290-70120 290-70240 290-70220 290-70260		Oil bottle 0,5 l SL14 SL15 SL16 SL18 SL19 Nr. 290-71140 290-71150 290-71160 290-71180 290-71190
--	----------------------------------------------------------------------------------------------------------------------------------------------------------------------------------------------------------------------------------------------------------------------------------------------------------------------------------	--	--------------------------------------------------------------------------------------------------------------------------------------------------------------------------

simalube IMPULSE accessories

	simalube IMPULSE connect pressure booster Nr. 230-10100		Battery pack Power 6 V 2,3 Ah Nr. 230-50000
--	-------------------------------------------------------------------------------	--	----------------------------------------------------------------------------

simatec – innovative solutions that deliver outstanding customer benefits

simatec is an international, Swiss family enterprise. Since its founding in 1983, this motivated team has been developing, manufacturing and marketing innovative products for the maintenance of rolling bearings under the brand names of simalube, simatherm and simatool.

The direct customer benefits are always at the forefront. Using newly developed technologies, simatec simplifies complex processes and reduces routine maintenance for tens of thousands of machines around the globe.

Selected distribution partners sell simatec maintenance products around the world. They provide professional service and individual, expert advice.

Maintenance products by simatec – industrial technology



Lubricators

The simalube lubricator provides automatic lubrication over a period of one month to a year and can be adjusted in an infinitely variable manner. simalube supplies every lubricating point with the ideal amount of lubricant – be it oil or grease – so that subsequent manual lubrication is no longer needed and maintenance costs are reduced in the long term.



Induction Heaters

simatherm induction heaters heat circular metal parts, such as roller bearings, in a very short amount of time, so they can be installed quickly and efficiently. The inductive heating of metallic workpieces makes sense from both an economical and ecological perspective. simatec is the world's leading manufacturer of these types of heaters.



Tools

The simatool toolkits enable the fast installation and removal of roller bearings and seals. They are used all over the world in machine and maintenance workshops within all industries.

simalube

simatherm

simatool

simatec inc.

13900-C South Lakes Drive
Charlotte, NC 28273
Tel.: (704) 588-3320
Fax: (704) 588-2112
info@simatec-usa.com
simatec-usa.com



simatec



simatec