

Automatic lubricators

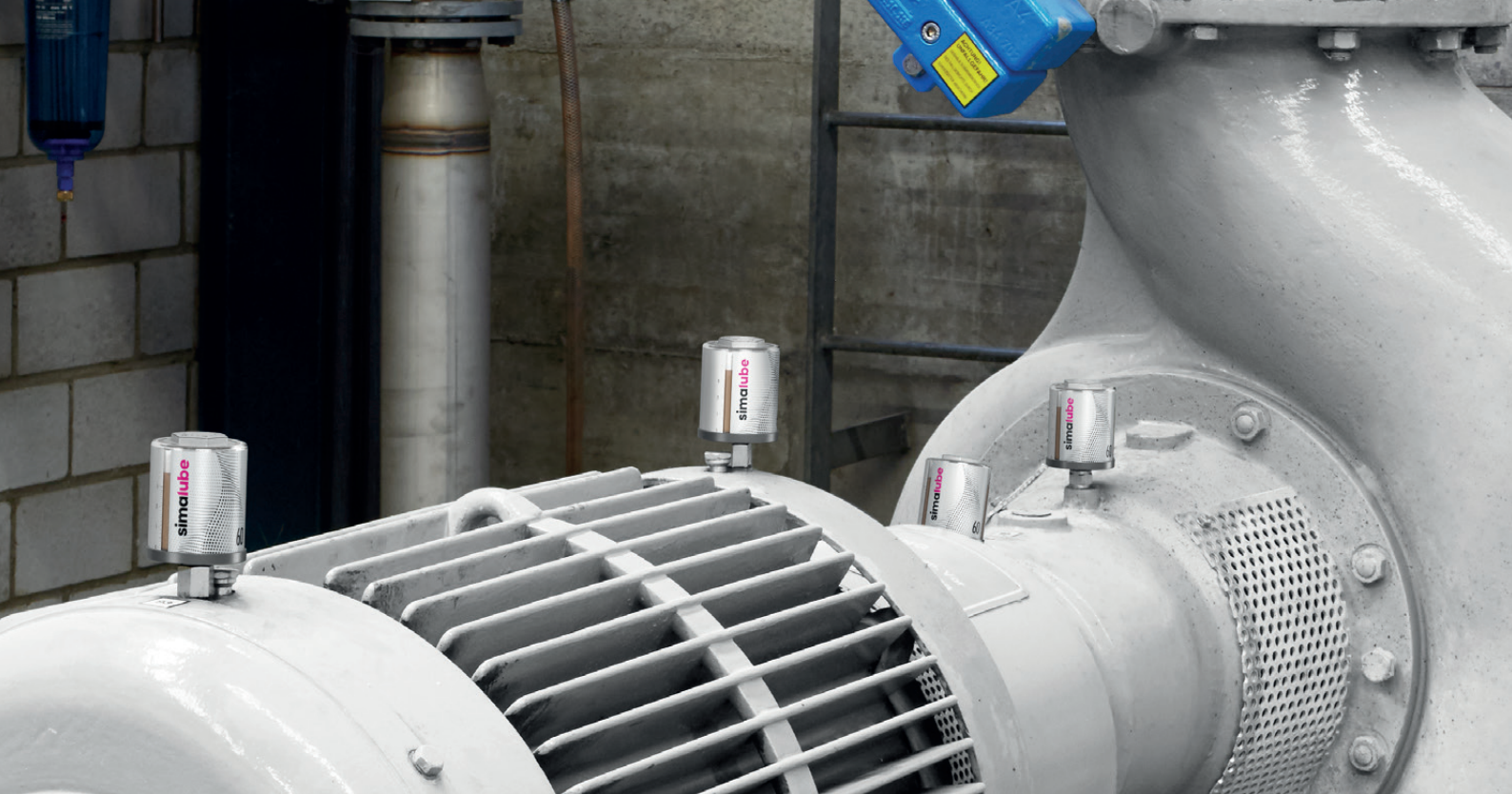

simalube

 SWISS MADE



simalube

Advantages of automatic lubrication with simalube	3
simatec app «simatec world of maintenance»	4
simalube – the lubrication expert	5/6
simalube 15 ml	7
simalube IMPULSE connect	8
simalube multipoint	9
Applications	10/11
Standard lubricants	12/13
Accessories	13/14/15

simalube: continuous lubrication ensures low costs and high reliability

Millions of simalube lubricators are used worldwide in every industry. They are the best and most economical solution for the continuous supply of grease or oil for periods of up to one year.

simalube – everywhere forces act, something spins or something moves.

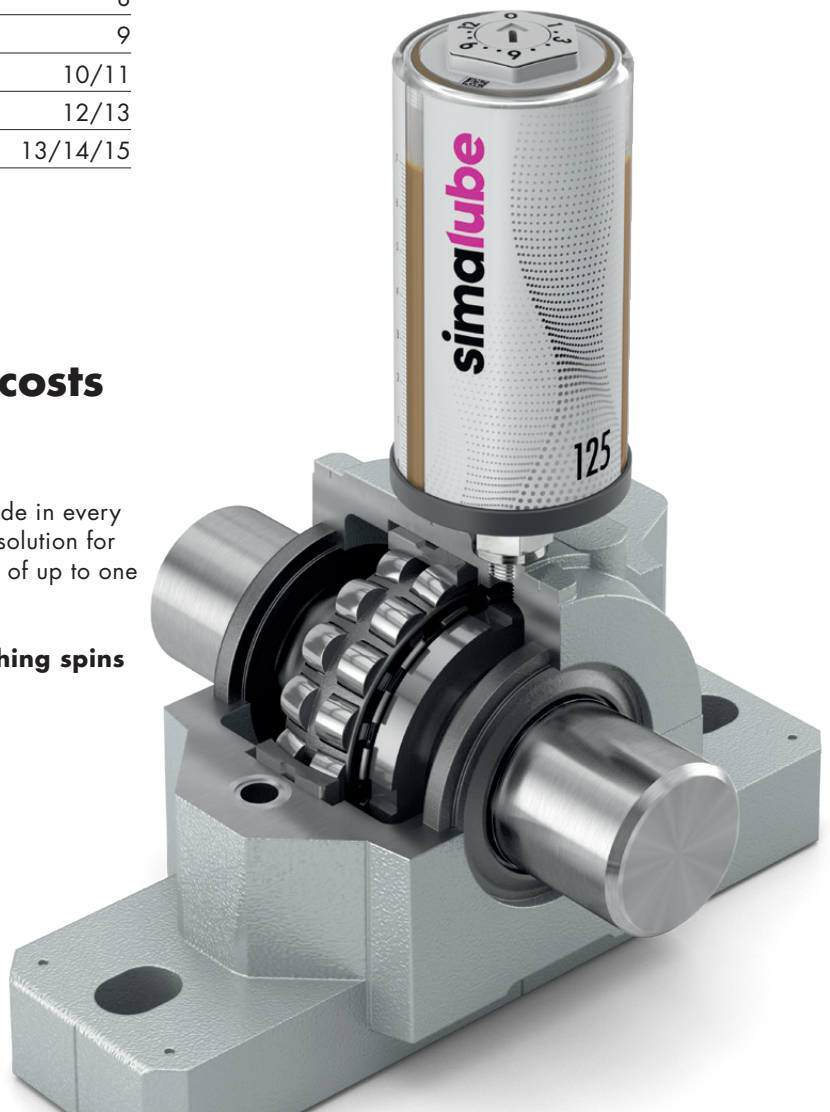

Advantages of automatic lubrication with simalube

simalube lubricators replace costly manual lubrication. This not only saves time, but also prevents insufficient or over-lubrication. The costs can thus be reduced by up to 30 percent.

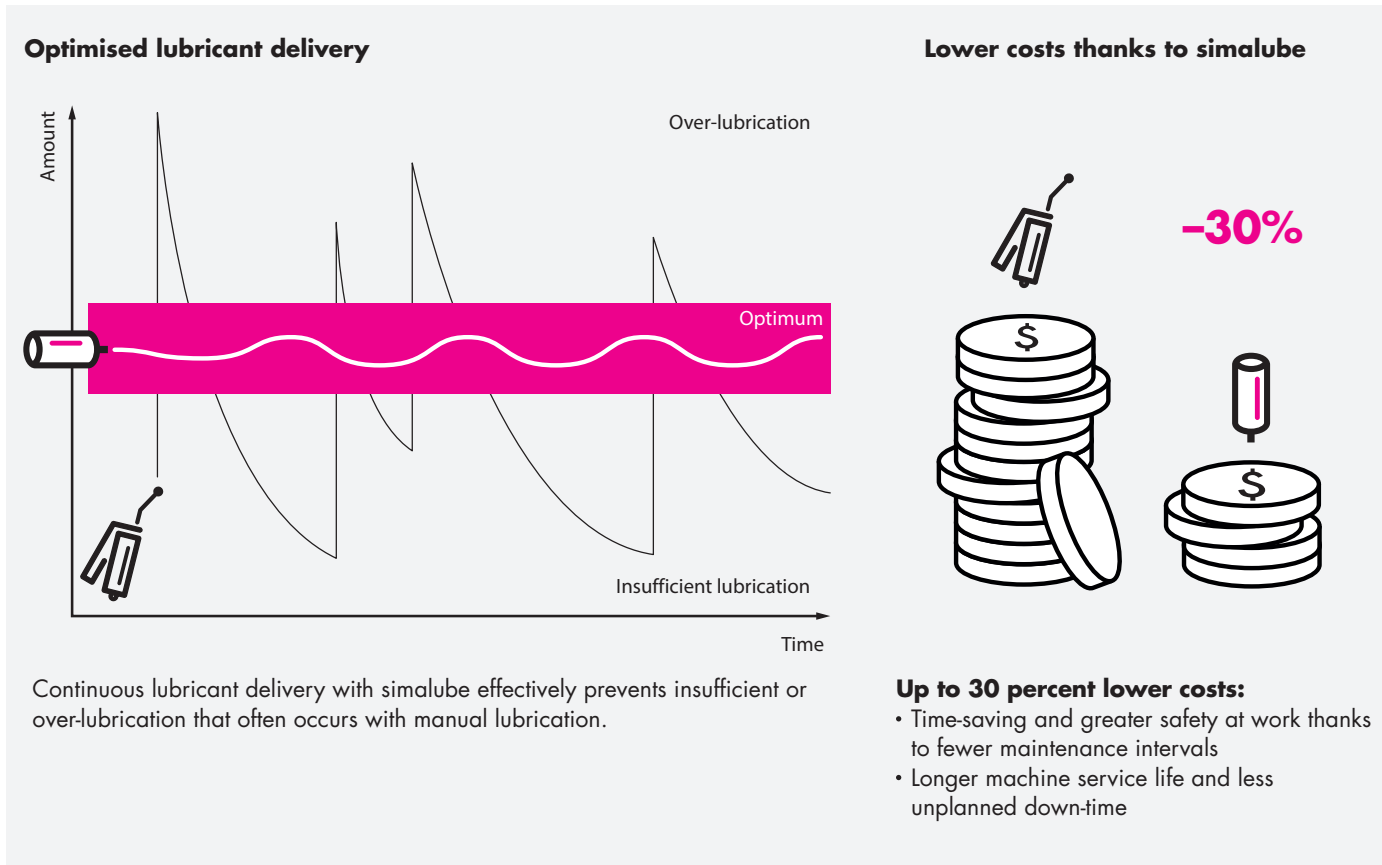

Your benefits of automatic lubrication with simalube



No more manual lubrication

- Saves time
- Greater work safety
- Hard-to-reach lubrication points are permanently supplied
- Lower lubricant consumption



No under- or over-lubrication of components

- Less wear
- Less machine downtime
- Increased machine performance

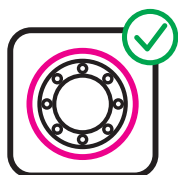

Sealed, dustproof and waterproof system

- No more confusion of lubricants
- Reduced risk of contamination
- No contamination of lubrication points



Compliance with international standards

- Ex certified in all zones
- Improved workplace safety
- No environmental impact thanks to recycling and disposal according to regulations



READY TO LIFT OFF TO THE WORLD OF MAINTENANCE



Explore the next level of automatic lubrication: **simalube IMPULSE connect**



simatec app «simatec world of maintenance»

With the simatec app «simatec world of maintenance», simatec ag has created a platform for simpler and more efficient management of lubrication work. The app offers the user the options of recording lubrication points, recording the required parameters for lubrication and controlling or monitoring all activities related to lubrication.

Your personal simatec assistant for efficient and connected monitoring

Functionality

- Configuration and monitoring of lubrication points with the «simatec world of maintenance» app
- Creation of electronic lubrication schedules (Lubechart)
- Calculation programme for the correct setting of your lubricators (Calculation Pro)

Customer benefits

- simatec products can be controlled with the «simatec world of maintenance» app
- Creation of personalised, electronic lubrication plans with continuous monitoring of all lubrication points
- Thanks to the new Lubechart feature, all lubrication points (manual/automatic) can be managed
- Cost savings thanks to safe, simplified and efficient maintenance operations
- Installation videos help with the correct installation of the products
- No production interruptions for maintenance and monitoring purposes, resulting in higher availability of the production facilities



Get the app «simatec world of maintenance»



The lubrication expert



simalube – the automatic single-point lubricator

Available in 5 sizes, simalube supplies various lubrication points with lubricant around the clock. Day in, day out – for up to one year.

Take advantage of the simalube benefits

Reliability

- Lubrication points are continuously supplied with lubricant
- No lubrication point is missed
- Easy monitoring of the dispensing process thanks to the transparent housing

Environmental sustainability

- simalube can be refilled up to 3 times
- Easy disposal at the end of the dispensing cycle
- simalube lubricators do not contain toxic substances

Flexibility

- simalube is available in 5 sizes: 15, 30, 60, 125 and 250 ml
- Freely selectable dispensing cycle of 1 to 12 months
- Dispensing cycle can be modified anytime
- simalube is available filled or empty for self-filling

Unlimited range of uses (see pages 10/11)

- In confined and hard-to-reach spaces
- In any location, even underwater
- At ambient temperatures of $-20\text{ }^{\circ}\text{C}$ to $+55\text{ }^{\circ}\text{C}$
- Numerous installation options thanks to a large range of accessories
- The standard lubricant range includes modern and proven high-performance lubricants for all applications (see pages 12/13)

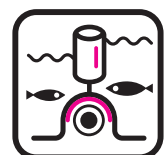
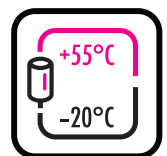
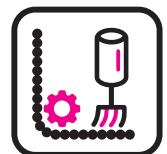

For more technical information, see
www.simatec.com/en/simalube/overview/technical-data



Components

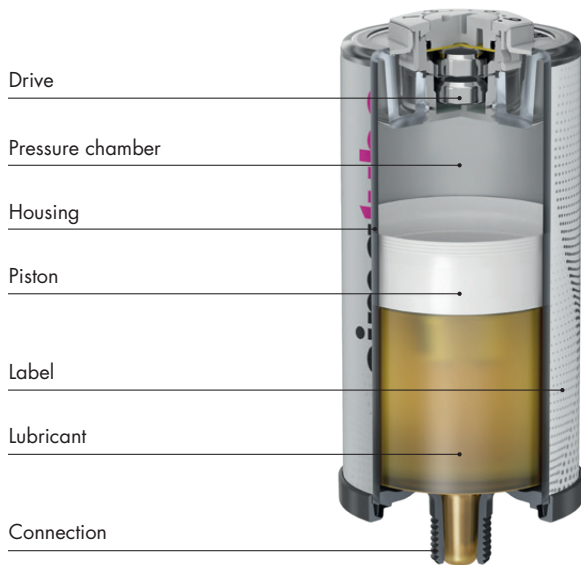

Specifications

Product	Automatic long-term grease and oil lubricator			
Power generation	Hydrogen gas producing drycell			
Working pressure	Max. 5 bar			
Adjustment	Stepless 1–12 months (for standard conditions)			
Operating temperature	–20 °C to +55 °C ambient temperature (Grease consistency changes with temperature)			
Storage temperature	Recommended at 20 °C ±5 °C			
Lubricator volume	30 ml	60 ml	125 ml	250 ml
Weight full	~83 g	~117 g	~191 g	~380 g
Weight empty	~56 g	~65 g	~80 g	~154 g
Refill	The 15–250 ml simalubes are refillable.			



Certifications

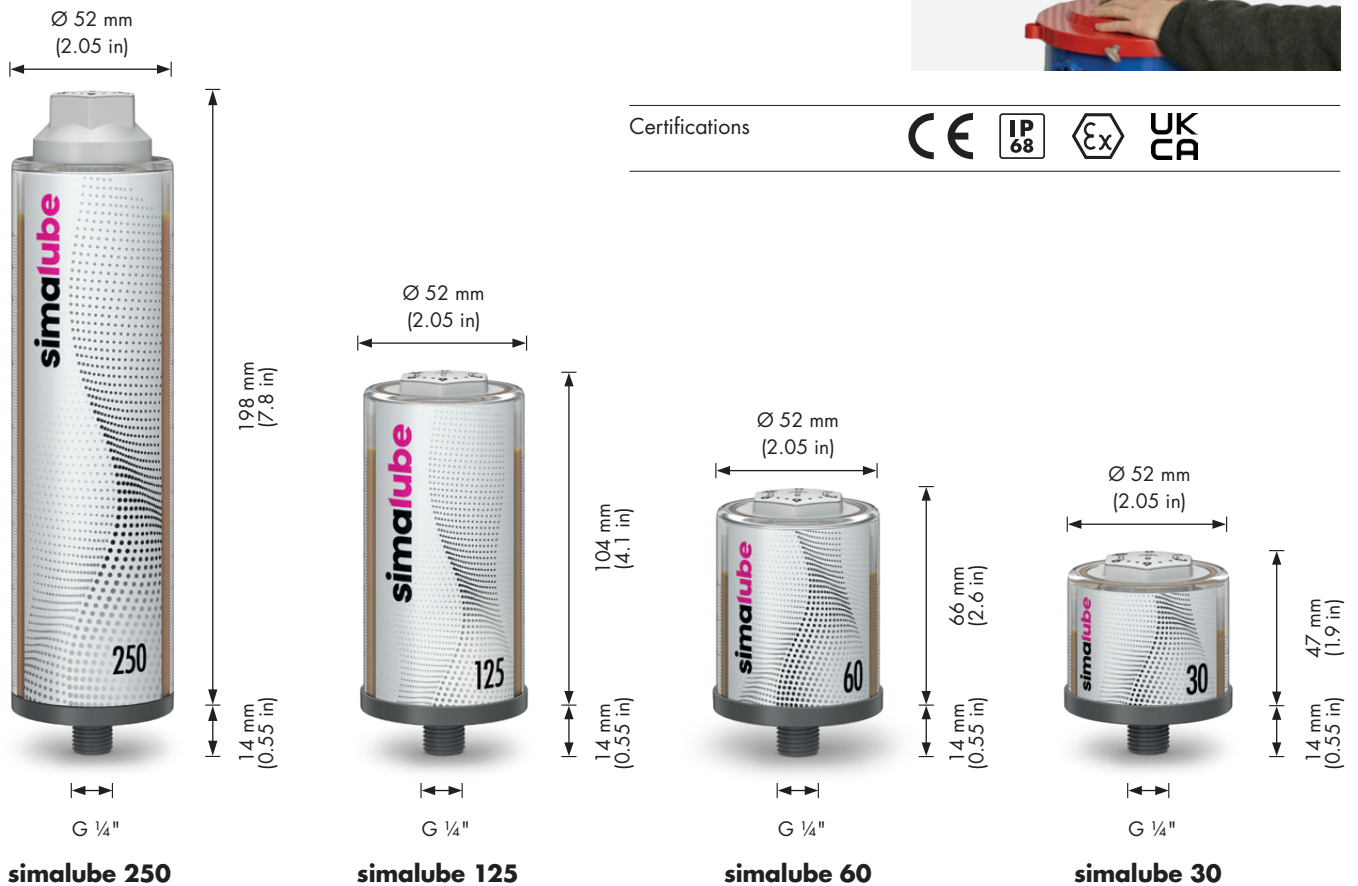

To determine the size and time setting, use our «Calculation Pro» programme on our free app.

simalube 15 ml

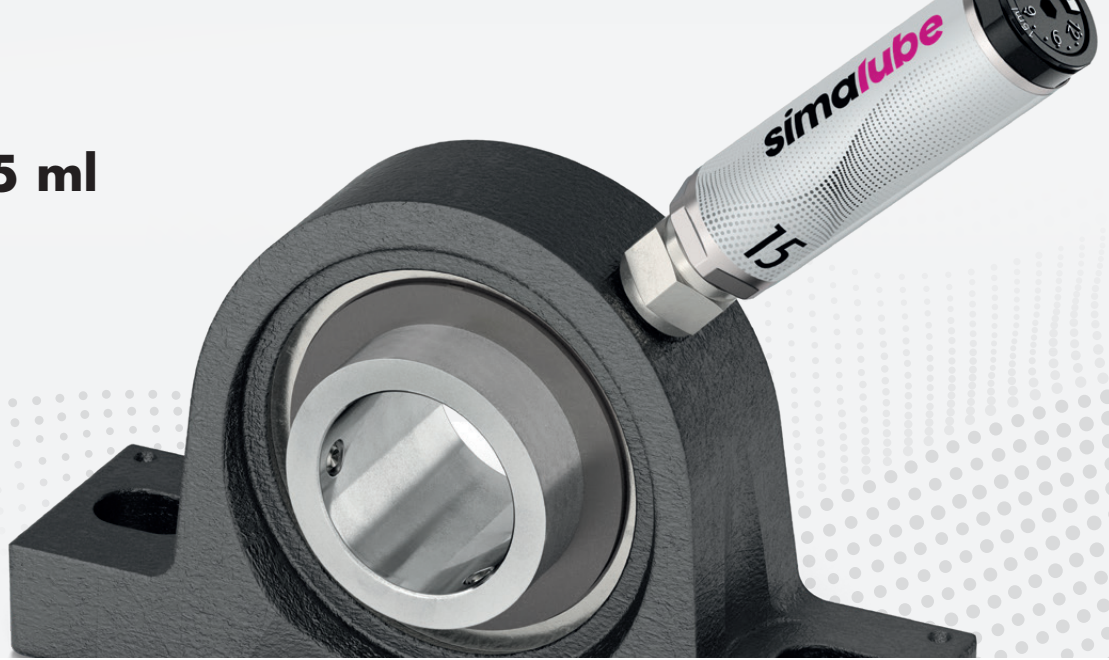

The smallest automatic lubricator

In confined spaces, the 15 ml simalube offers the perfect solution. With its compact size, it is unique on the global market as the smallest automatic lubricator. It functions the same as the larger simalube lubricators and offers the same advantages.



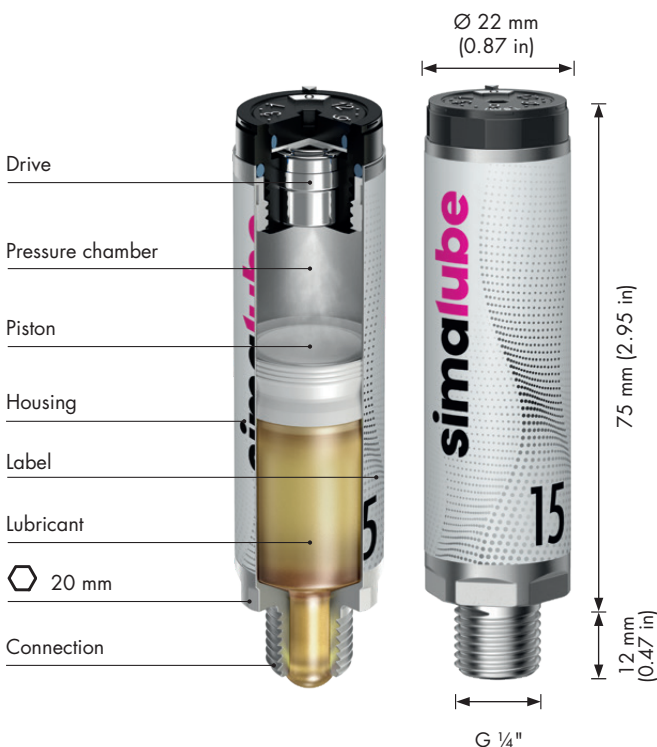

Small size delivers big performance

- Space-saving thanks to compact size
- Robust aluminium enclosure
- Same refill, installation and function as other simalube lubricators
- Alternative to the simalube multipoint when less than 5 lubrication points are needed (see page 9)

Dimensions



Specifications

Product	Automatic, long-term grease and oil lubricator
Power generation	Hydrogen gas producing drycell
Working pressure	Max. 5 bar
Adjustment	Stepless 1–12 months (for standard conditions)
Operating temperature	–20 °C to +55 °C ambient temperature (Grease consistency changes with temperature)
Storage temperature	Recommended at 20 °C ±5 °C
Lubricator volume	15 ml
Weight full/empty	~36 g / ~22,5 g
Certifications	   

simalube IMPULSE connect



Digital pressure booster up to 10 bar

The simalube IMPULSE connect is the latest generation of the pressure booster from the simalube family. The proven functions of the IMPULSE have been supplemented with the option of connecting the device to a smartphone via Bluetooth®. In connection with the newly developed «simatec world of maintenance» app, the devices can be easily configured and then monitored without having to be directly at the lubrication point. Information such as general status, fill level, lubricant, size, start and change date etc. is displayed to the user and easy to read in the app.

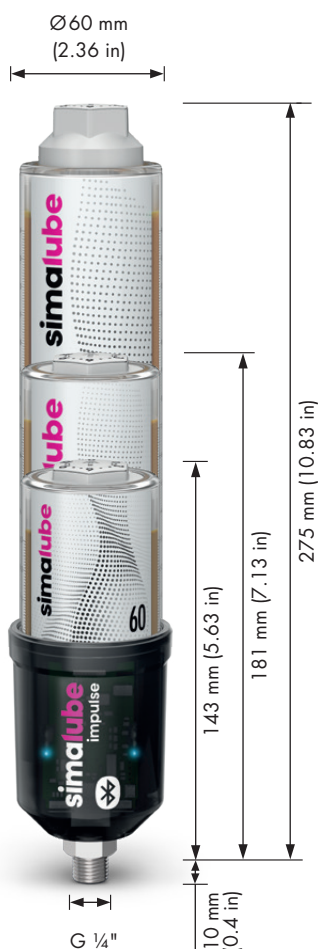

Technical data

Product	Automatic pressure booster for the simalube lubricator
Drive system	Electromechanical
Power supply	Battery pack* 6 V 2.3 Ah (Alkaline)
Function display	LED status display – green/red/blue every 10 seconds. Monitoring of the operating status via the «simatec world of maintenance» app.
Connectivity**	IMPULSE connect supports Bluetooth® Low Energy 5.0 standard. The connection can reach up to 20 m in an interference free open field environment.
Dispensing volume	0.5 ml per stroke (Impulse)
Working pressure	Up to 10 bar
Operating temperature	-10 °C to +55 °C (14 °F to 131 °F)
Time setting	1 to 12 months – determined by the setting on the simalube «Automatic» mode or the «Time» mode preselected with the app.
Lubrication rate	Depends on the size and settings of the simalube: 0.17 to 8.3 ml/day
Lubricator volume	60 ml, 125 ml, 250 ml
Lubricant	Lubricant greases up to NLGI 2 or oils
Connection thread	G ¼" (with integrated non-return valve)
Warranty & period of use	3 years from the production date or until 10 simalube lubricators (125 ml) have been emptied
Protection rating	CE IP 68

* The battery pack must be replaced every time the lubricator is replaced.

** The IMPULSE connect can be used without the app.



More technical information and a video for simalube IMPULSE connect can be found at www.simatec.com/en/simalube/simalube-impulse-connect



simalube multipoint



Automatic multi-point lubricator

The simalube multipoint supplies 5 lubrication points simultaneously for up to one year in the same reliable way as the other proven simalube lubricators. Thanks to the snap-on connector, simalube multipoint can be replaced easily and quickly when empty.



The versatile lubricator for linear guides

- 5x8 ml lubricant volume
- Allows very low lubricant delivery over a long period of time
- Snap-on connector for multipoint
- Quick couplings for connecting hoses
- Ideally suited for lubrication of linear guides

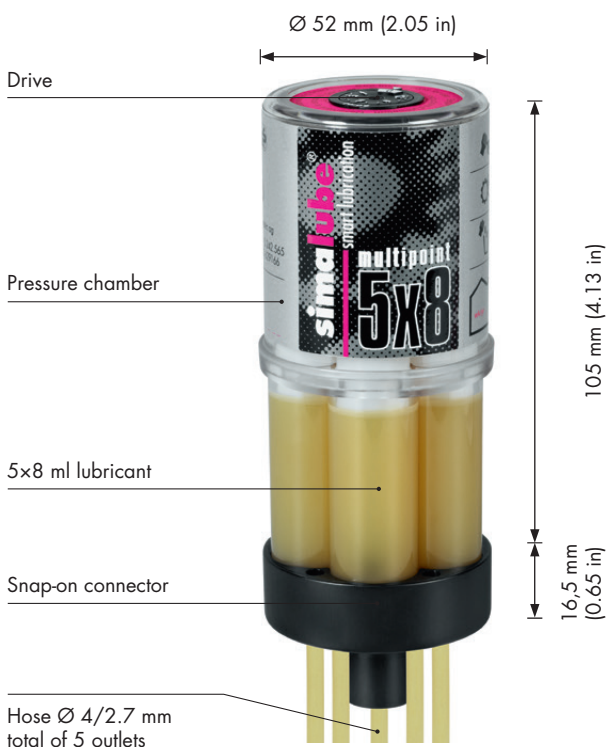
Dimensions



Specifications

Product	Automatic, multi-point, long-term lubricators for grease and oil
Power generation	Hydrogen gas producing drycell
Working pressure	Max. 5 bar
Adjustment	Stepless 1–12 months (for standard conditions)
Operating temperature	-20 °C to +55 °C ambient temperature (grease consistency changes with temperature)
Storage temperature	Recommended at 20 °C \pm 5 °C
Lubricator volume	5x8 ml
Weight full/empty	~147 g / ~120 g
Certifications	  

simalube applications



Lifting devices



The spindles of a lifting station for railway wagons and locomotives are lubricated with 125 ml simalube over 12 months.

Food industry

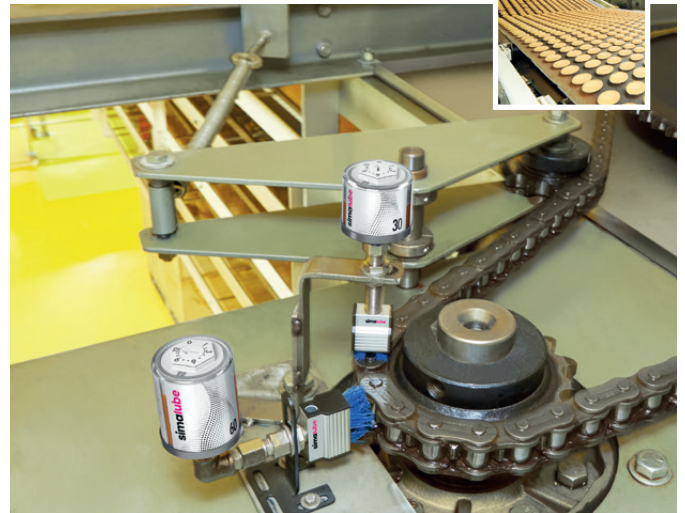

The drive chain of a transport belt, which allows rolls to cool, is cleaned with special blue brushes and lubricated with 2 simalube SL18 in 30 and 60 ml sizes.

Gravel and concrete plants



Two 250 ml simalube lubricators with brushes lubricate and clean the chain drive of a drum washing machine.

Cranes



125 ml simalube lubricators lubricate the rotating assembly of a crane.

Gravel and concrete plants



The simalube IMPULSE connect with a 125 ml lubricator is used in gravel plants. The devices are configured and monitored via the «simatec world of maintenance» app.

Elevators and escalators

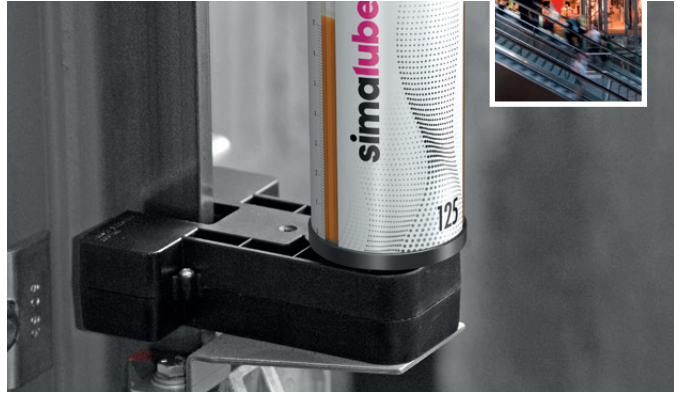

The 125 ml simalube maintains the guide rails of elevators and prevents dry friction. The system is attached directly to the cabin roof.

Printing industry

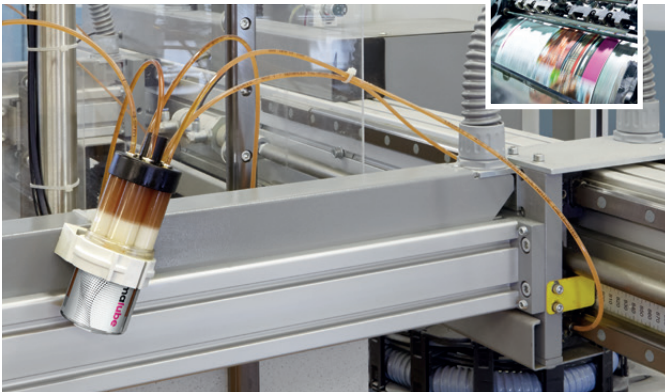

A simalube multipoint can lubricate 5 linear guides of a cutting and paper stacking machine in a printing house.

Water and sewage treatment plants

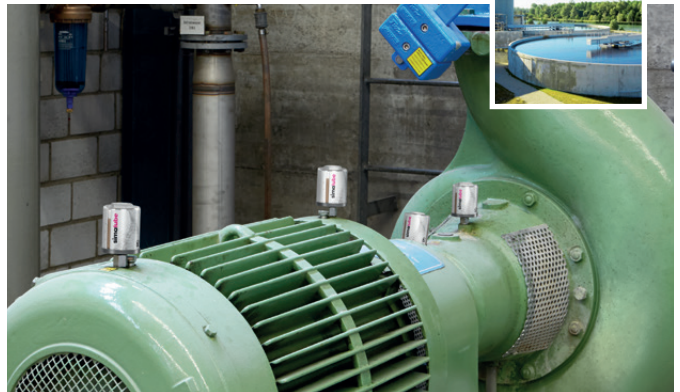

60 ml lubricators on the electric motor and the drive shaft ensure continuous lubrication of a centrifugal pump.

Recycling



A 125 ml simalube lubricates the pedestal bearing of a conveyor belt.

Machinery and plant engineering

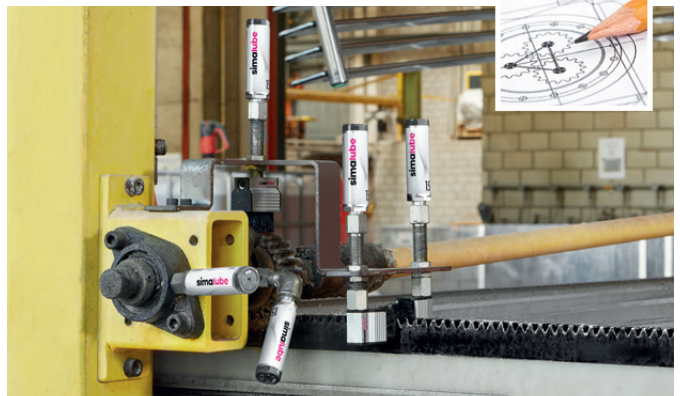

15 ml simalube lubricators with brushes constantly supply the rack of a loading machine with oil. Additional 15 ml simalube lubricators lubricate the flange bearings with grease.











Many other applications can be found at www.simatec.com/en/simalube/industries





simalube standard lubricants and accessories

GREASE					Roller bearings	Plain bearings	Linear guides	Gears/Toothed racks	Spindles	Shaft seals	Chains
	NLGI	Thickener	Temperature range	Viscosity at 40 °C							
SL01 Multipurpose grease	2	Lithium-calcium	-30 °C to 120 °C	100	+	+	•	•	+	+	-
SL02 Multipurpose grease with MoS ₂	2	Lithium	-25 °C to 130 °C	370	•	+	-	+	-	-	-
SL04 High temperature grease	2	Inorganic thickener	-20 °C to 160 °C	500	+	•	-	•	•	-	-
SL06 Fluid grease (EP)	0	Calcium-lithium	-30 °C to 100 °C	75	+	+	+	+	•	-	-
SL09 Biodegradable grease	2	Lithium-calcium	-20 °C to 100 °C	100	+	+	•	•	-	-	-
SL10 Food industry grease (NSF H1) 	2	Aluminium complex	-40 °C to 120 °C	330	+	+	•	+	•	-	-
SL12 Food industry fluid grease (NSF H1) 	0	Aluminium complex	-40 °C to 130 °C	350	+	+	+	+	•	-	-
SL22 Electric motor bearing grease	2	Polyurea	-20 °C to 160 °C	115	+	•	-	•	•	-	-
SL24 Grease for a wide temperature range (EP)	2	Lithium complex	-30 °C to 140 °C	185	+	+	•	•	+	+	-
SL26 High performance grease (EP)	1,5	Calcium complex	-20 °C to 150 °C	390	+	+	-	•	•	-	-

+ recommended • possible - not recommended



Datasheets are available for all greases and oils at www.simatec.com/en/simalube/overview/lubricants



OIL	ISO-VG	Base oil	Temperature range	Viscosity at 40 °C	Roller bearings	Plain bearings	Linear guides	Gears/Toothed racks	Spindles	Shaft seals	Chains
SL14 Chain oil (EP)	68	Mineral oil	-10 °C to 90 °C	68	-	•	•	-	-	-	+
SL15 High temperature chain oil (EP)	-	Synthetic oil	-30 °C to 250 °C	250	-	•	•	-	-	-	+
SL16 Machine oil	68	Mineral oil	-20 °C to 100 °C	68	-	•	•	-	-	-	+
SL18 Food industry oil (NSF H1)	220	Synthetic oil	-15 °C to 150 °C	220	-	•	•	-	-	-	+
SL19 Biodegradable chain oil	-	Rapeseed oil	-15 °C to 100 °C	60	-	•	•	-	-	-	+

+ recommended • possible - not recommended

Application examples

The simalube can be easily installed anywhere and in any position with these accessories.

Chain lubrication with lateral connection

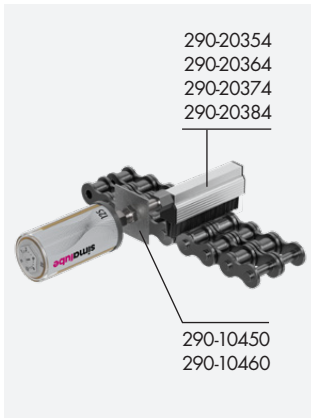

Mounting bracket

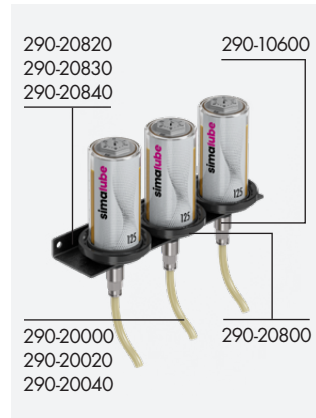

Lubrication of elevator guides or wire ropes



Chain lubrication with round brush and two clamps

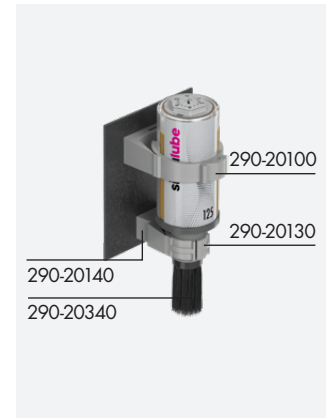

Mounting support with protective cover for simalube

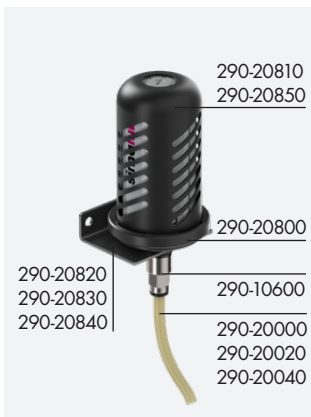

Chain lubrication with clamp



Round brush with 90° connection



Chain lubrication with bracket, universally adjustable

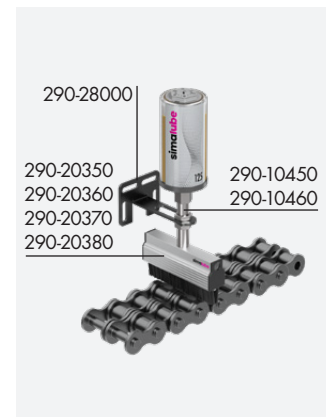

Connections

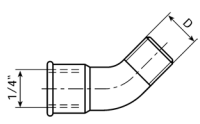
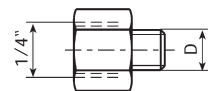
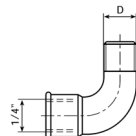
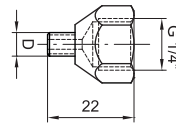
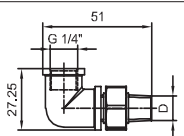
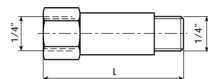
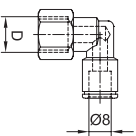
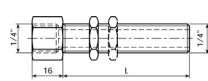
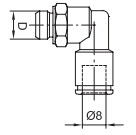
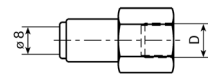
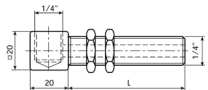
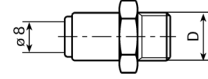
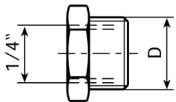
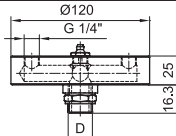
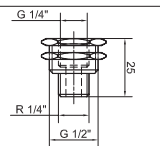
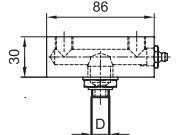
	Bent connection 45° D R 1/4 Nr. 290-10010		Reducing nipple D G 1/8 G 1/4 M 6 M 8 M 8x1 Nr. 290-10200 290-10210 290-10220 290-10230 290-10240 D M 10 M 10x1 M 12 M 12x1,5 UNF 1/4 Nr. 290-10250 290-10260 290-10270 290-10280 290-11210
	Bent connection 90° D R 1/4 Nr. 290-10020		Reducing nipple strong version Inox D M6 UNF 1/4 Nr. 290-15000 290-15010
	Bent connection 90° swiveling D R 1/4 Nr. 290-10040		Extension L 10 35 50 [mm] Nr. 290-10210 290-10400 290-10410
	Rotary elbow for hose Ø 8 mm D G 1/4 Nr. 290-10030		Screwed connection with hole 25 mm incl. 1 nut / 60 mm, incl. 2 nuts L 25 60 [mm] Nr. 290-10450 290-10460
	Rotary elbow for hose Ø 8 mm D G 1/8 G 1/4 Nr. 290-10070 290-10080		Quick connection for hose Ø 8 mm D G 1/4 Nr. 290-10600
	Connection 90° with thread incl. 2 nuts (only for oil) L 70 [mm] Nr. 290-10050		Quick connection for hose Ø 8 mm D G 1/8 G 1/4 G 3/8 Nr. 290-10700 290-10710 290-10720
	Connecting nipple D G 3/8 G 1/2 Nr. 290-10100 290-10110		4-fold adapter D G 1/2 G 1/4 Nr. 290-41000 290-41010
	Fixation nipple G 1/2" - R 1/4" L 25 [mm] Nr. 290-10150		2-fold adapter D G 1/2 G 1/4 Nr. 290-41020 290-41030

Lubricator accessories and miscellaneous

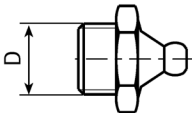
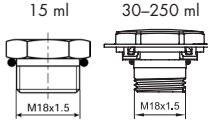
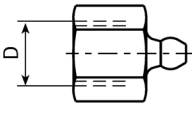
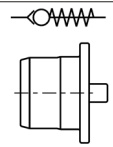
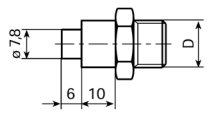
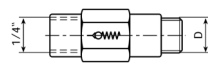
	Filling nipple for cleaning and filling of grease lines D R 1/4 Nr. 290-30110		Gas generator for refilling <table border="1"> <tr> <td>15 ml</td> <td>30 ml</td> <td>60 ml</td> <td>125 ml</td> <td>250 ml</td> </tr> <tr> <td>Nr. 220-50020</td> <td>220-50040</td> <td>220-50060</td> <td>220-50080</td> <td>220-50100</td> </tr> </table>	15 ml	30 ml	60 ml	125 ml	250 ml	Nr. 220-50020	220-50040	220-50060	220-50080	220-50100
15 ml	30 ml	60 ml	125 ml	250 ml									
Nr. 220-50020	220-50040	220-50060	220-50080	220-50100									
	Refill nipple for refilling of simalube D G 1/4 Nr. 290-30120		Non-return valve plug Plastic Nr. 290-50600										
	Refill nipple for filling the simalube with grease gun filler D R 1/4 R 3/8 Nr. 290-30130 290-30140		Non-return valve D G 1/8 G 1/4 G 1/4 Nr. 290-20200 290-20210 290-20230 Bar 0.05 0.05 1.0										

Safety accessories

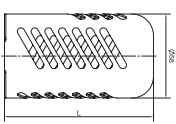
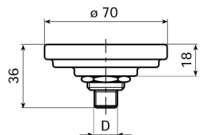
	Protective cover for mounting support art. 290-20800 <table border="1"> <tr> <td>30 ml</td> <td>≤125 ml</td> <td>250 ml</td> </tr> <tr> <td>L 43</td> <td>105</td> <td>195 [mm]</td> </tr> <tr> <td>Nr. 290-20860</td> <td>290-20810</td> <td>290-20850</td> </tr> </table>	30 ml	≤125 ml	250 ml	L 43	105	195 [mm]	Nr. 290-20860	290-20810	290-20850		Mounting support for all simalube sizes D R 1/4 Nr. 290-20800
30 ml	≤125 ml	250 ml										
L 43	105	195 [mm]										
Nr. 290-20860	290-20810	290-20850										

Brushes

	Round brush DxL $\varnothing 25 \times 45$ [mm] Nr. 290-20340		Brush for high temperatures Connection on top H 25 [mm] Nr. 290-20500																		
	Round brush short DxL $\varnothing 25 \times 15$ [mm] Nr. 290-20410		Brush for high temperatures Connection on top and side H 40 100 [mm] Nr. 290-20510 290-20530																		
	Brush *For food applications <table border="1"> <tr> <td>L</td> <td>25</td> <td>40</td> <td>70</td> <td>100</td> <td>[mm]</td> </tr> <tr> <td>Nr.</td> <td>290-20380</td> <td>290-20350</td> <td>290-20360</td> <td>290-20370</td> <td></td> </tr> <tr> <td>Nr.</td> <td>*290-20385</td> <td>*290-20355</td> <td>*290-20365</td> <td>*290-20375</td> <td></td> </tr> </table>	L	25	40	70	100	[mm]	Nr.	290-20380	290-20350	290-20360	290-20370		Nr.	*290-20385	*290-20355	*290-20365	*290-20375			Elevator brush Elevator brush 5-16 mm, height 32 mm 16-32 mm, height 32 mm Nr. 290-20390 Nr. 290-20440
L	25	40	70	100	[mm]																
Nr.	290-20380	290-20350	290-20360	290-20370																	
Nr.	*290-20385	*290-20355	*290-20365	*290-20375																	
	Brush lateral connection *For food applications <table border="1"> <tr> <td>L</td> <td>25</td> <td>40</td> <td>70</td> <td>100</td> </tr> <tr> <td>Nr.</td> <td>290-20384</td> <td>290-20354</td> <td>290-20364</td> <td>290-20374</td> </tr> <tr> <td>Nr.</td> <td></td> <td>*290-20357</td> <td>*290-20367</td> <td>*290-20377</td> </tr> </table>	L	25	40	70	100	Nr.	290-20384	290-20354	290-20364	290-20374	Nr.		*290-20357	*290-20367	*290-20377		Elevator brush small 5-16 mm, height 32 mm Nr. 290-20420			
L	25	40	70	100																	
Nr.	290-20384	290-20354	290-20364	290-20374																	
Nr.		*290-20357	*290-20367	*290-20377																	

Installation accessories

	a) Hose b) Hose for temperatures up to 260 °C c) Hose for small bend radius <table border="1"> <tr> <td>L</td> <td colspan="3">available by the metre, $\varnothing 8/6$ mm</td> </tr> <tr> <td>Nr.</td> <td>290-20000/...m</td> <td>290-20020/...m</td> <td>290-20040/...m</td> </tr> </table>	L	available by the metre, $\varnothing 8/6$ mm			Nr.	290-20000/...m	290-20020/...m	290-20040/...m		Distance holder to clamp for round brush art. 290-20130 H 15 [mm] Nr. 290-20140														
L	available by the metre, $\varnothing 8/6$ mm																								
Nr.	290-20000/...m	290-20020/...m	290-20040/...m																						
	Clamp for simalube/round brush Plastic <table border="1"> <tr> <td>D</td> <td>22 (SL 15 ml)</td> <td>28 (Brush)</td> <td>50 (SL 30-250 ml)</td> <td>[mm]</td> </tr> <tr> <td>Nr.</td> <td>290-20150</td> <td>290-20130</td> <td>290-20100</td> <td></td> </tr> </table>	D	22 (SL 15 ml)	28 (Brush)	50 (SL 30-250 ml)	[mm]	Nr.	290-20150	290-20130	290-20100			Bracket to mounting support simalube art. 290-20800 <table border="1"> <tr> <td></td> <td>1x</td> <td>3x</td> <td>5x</td> </tr> <tr> <td>L</td> <td>75</td> <td>240</td> <td>390</td> </tr> <tr> <td>Nr.</td> <td>290-20820</td> <td>290-20830</td> <td>290-20840</td> </tr> </table>		1x	3x	5x	L	75	240	390	Nr.	290-20820	290-20830	290-20840
D	22 (SL 15 ml)	28 (Brush)	50 (SL 30-250 ml)	[mm]																					
Nr.	290-20150	290-20130	290-20100																						
	1x	3x	5x																						
L	75	240	390																						
Nr.	290-20820	290-20830	290-20840																						
	Magnetic fixture for clamps Nr. 290-20190		Bracket for simalube 15-60 ml Nr. 290-20870																						
	Adapter for clamp (60 mm) Plastic <table border="1"> <tr> <td>D</td> <td>50 [mm]</td> </tr> <tr> <td>Nr.</td> <td>290-20120</td> </tr> </table>	D	50 [mm]	Nr.	290-20120		Bracket universally adjustable Nr. 290-28000																		
D	50 [mm]																								
Nr.	290-20120																								

simalube multipoint installation components

	Quick connection for hose $\varnothing 4$ mm <table border="1"> <tr> <td>D</td> <td>G 1/8</td> <td>G 1/4</td> <td>M 5</td> <td>M 6</td> </tr> <tr> <td>Nr.</td> <td>290-11700</td> <td>290-11710</td> <td>290-11720</td> <td>290-11730</td> </tr> </table>	D	G 1/8	G 1/4	M 5	M 6	Nr.	290-11700	290-11710	290-11720	290-11730		Hose available by the metre <table border="1"> <tr> <td>L</td> <td>per metre</td> <td>$\varnothing 4/2,7$ mm</td> </tr> <tr> <td>Nr.</td> <td colspan="2">290-21000/...m</td> </tr> </table>	L	per metre	$\varnothing 4/2,7$ mm	Nr.	290-21000/...m	
D	G 1/8	G 1/4	M 5	M 6															
Nr.	290-11700	290-11710	290-11720	290-11730															
L	per metre	$\varnothing 4/2,7$ mm																	
Nr.	290-21000/...m																		
	Connection SLM <table border="1"> <tr> <td>D</td> <td>5x $\varnothing 4$ mm</td> </tr> <tr> <td>Nr.</td> <td>290-29000</td> </tr> </table>	D	5x $\varnothing 4$ mm	Nr.	290-29000														
D	5x $\varnothing 4$ mm																		
Nr.	290-29000																		

Grease cartridges and oil bottles for prelubrication

	Grease cartridge 400 ml <table border="1"> <tr> <td></td> <td>SL01</td> <td>SL02</td> <td>SL04</td> <td>SL06</td> <td>SL09</td> </tr> <tr> <td>Nr.</td> <td>290-70010</td> <td>290-70020</td> <td>290-70040</td> <td>290-70060</td> <td>290-70090</td> </tr> <tr> <td></td> <td>SL10</td> <td>SL12</td> <td>SL24</td> <td>SL22</td> <td>SL26</td> </tr> <tr> <td>Nr.</td> <td>290-70100</td> <td>290-70120</td> <td>290-70240</td> <td>290-70220</td> <td>290-70260</td> </tr> </table>		SL01	SL02	SL04	SL06	SL09	Nr.	290-70010	290-70020	290-70040	290-70060	290-70090		SL10	SL12	SL24	SL22	SL26	Nr.	290-70100	290-70120	290-70240	290-70220	290-70260		Oil bottle 0,5 l <table border="1"> <tr> <td></td> <td>SL14</td> <td>SL15</td> <td>SL16</td> <td>SL18</td> <td>SL19</td> </tr> <tr> <td>Nr.</td> <td>290-71140</td> <td>290-71150</td> <td>290-71160</td> <td>290-71180</td> <td>290-71190</td> </tr> </table>		SL14	SL15	SL16	SL18	SL19	Nr.	290-71140	290-71150	290-71160	290-71180	290-71190
	SL01	SL02	SL04	SL06	SL09																																		
Nr.	290-70010	290-70020	290-70040	290-70060	290-70090																																		
	SL10	SL12	SL24	SL22	SL26																																		
Nr.	290-70100	290-70120	290-70240	290-70220	290-70260																																		
	SL14	SL15	SL16	SL18	SL19																																		
Nr.	290-71140	290-71150	290-71160	290-71180	290-71190																																		

simalube IMPULSE accessories

	simalube IMPULSE connect pressure booster Nr. 230-10100		Battery pack <table border="1"> <tr> <td>Power</td> <td>6 V 2,3 Ah</td> </tr> <tr> <td>Nr.</td> <td>230-50000</td> </tr> </table>	Power	6 V 2,3 Ah	Nr.	230-50000
Power	6 V 2,3 Ah						
Nr.	230-50000						

simatec – innovative solutions that deliver outstanding customer benefits

simatec is an international, Swiss family enterprise. Since its founding in 1983, this motivated team has been developing, manufacturing and marketing innovative products for the maintenance of rolling bearings under the brand names of simalube, simatherm and simatool.

The direct customer benefits are always at the forefront. Using newly developed technologies, simatec simplifies complex processes and reduces routine maintenance for tens of thousands of machines around the globe.

Selected distribution partners sell simatec maintenance products around the world. They provide professional service and individual, expert advice.

Maintenance products by simatec – industrial technology



Lubricators

The simalube lubricator provides automatic lubrication over a period of one month to a year and can be adjusted in an infinitely variable manner. simalube supplies every lubricating point with the ideal amount of lubricant – be it oil or grease – so that subsequent manual lubrication is no longer needed and maintenance costs are reduced in the long term.



Induction Heaters

simatherm induction heaters heat circular metal parts, such as roller bearings, in a very short amount of time, so they can be installed quickly and efficiently. The inductive heating of metallic workpieces makes sense from both an economical and ecological perspective. simatec is the world's leading manufacturer of these types of heaters.



Tools

The simatool toolkits enable the fast installation and removal of roller bearings and seals. They are used all over the world in machine and maintenance workshops within all industries.

simalube

simatherm

simatool



simatec



simatec

simatec gmbh

Christinstrasse 16
D-75177 Pforzheim

Tel.: +49 7231 139 8200

Fax: +49 7231 139 8229

willkommen@simatec.com

simatec.de